









GENERAL CATALOGUE
TV Reception

www.fagorelectronica.com

FAGOR 
Fagor Electrónica

General Catalogue 2014

GENERAL INDEX	Pg.
SIGNAL RECEPTION	2
 <ul style="list-style-type: none"> • Terrestrial antennas • Satellite dishes • Converters • 1st IF SAT Line Amplifier 	
HEADENDS	13
 <ul style="list-style-type: none"> • 8000 series headend • 6000/7000 series headend • Channel amplifier - NEXUM series • Programmable amplifiers - MICROMATV series • Headend multiband amplifiers • Digital modulator • Multiswitches 	
AMPLIFICATION	69
 <ul style="list-style-type: none"> • Filters • Mast amplifiers • Indoor amplifiers & modulators • Distribution amplifiers 	
DTT RECEIVERS	84
 <ul style="list-style-type: none"> • DTT receivers 	
DISTRIBUTION	86
 <ul style="list-style-type: none"> • Tap-offs & splitters • Outlet sockets • Shielded diplexer • Coaxial cables 	
ACCESSORIES	94
 <ul style="list-style-type: none"> • Connectors • Amplifiers • Attenuators • 75 Ω loads • Combiners & diplexers • Filters • DC injectors • Weatherproof protectors 	
TECHNICAL NOTES	97
 <ul style="list-style-type: none"> • Technical Notes 	

ANF BIII Series

6, 9 and 13 elements BIII antennas.

APPLICATION

Terrestrial TV installations, community and individual.

CHARACTERISTICS

- Robust, strong antenna, made of aluminium.
- Waterproof connection box.
- F connectors.
- Quick installation.

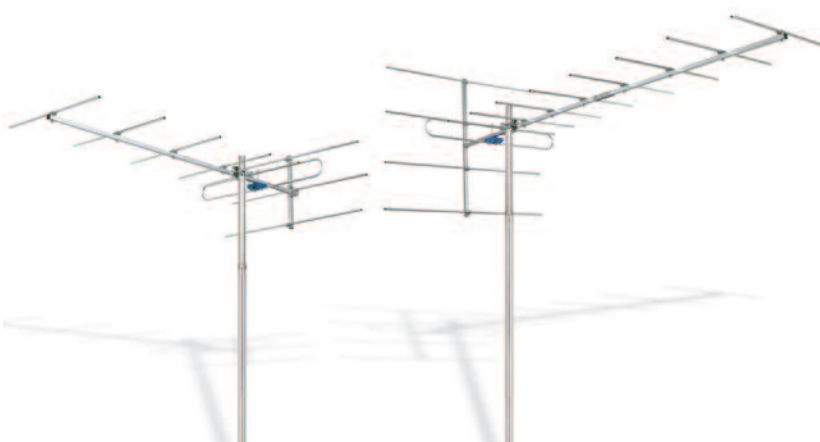

ANF BIII9

ANF BIII13

MODEL	ANF BIII	ANF BIII9	ANF BIII13
Reference	80021	80027	80028
Channels	E05 ... E12		
Nbr. of elements	6	9	13
Gain	7,5	10	12
Impedance	75		
Front-to-back ratio	18	22	30
Length	1220	1536	2074
Units per package	10	1 / 10	1 / 6
Dimensions of packaging	1330 x 240 x 220	950 x 120 x 70 965 x 370 x 260	1400 x 130 x 70 1425 x 270 x 230
Weight	10,5	1,5 / 16	2 / 12,8

ANF RADIO Series

Terrestrial antennas for analogue and digital DAB radio.

APPLICATION

Community and individual installations of digital and analogue radio reception.

CHARACTERISTICS

- Made of aluminium.
- Waterproof connection box.
- F connectors.
- Quick installation.
- Omnidirectional.
- ANF DAB: Antenna for digital radio reception.

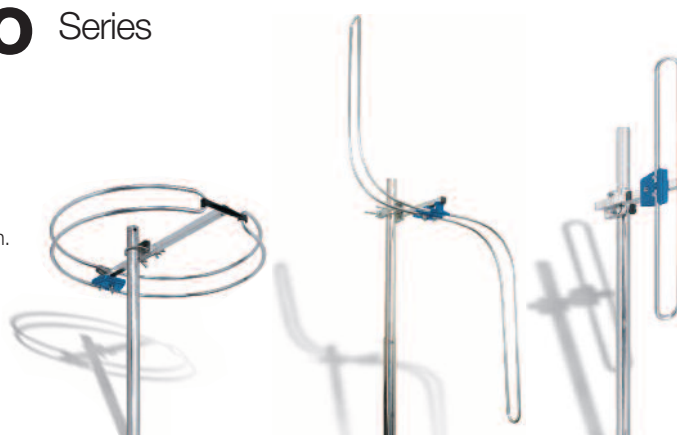

ANF FM

ANF FMS

ANF DAB

MODEL	ANF FM	ANF FMS	ANF DAB
Reference	80024	80025	80026
Frequency range	87,5 ÷ 108		193 ÷ 230
Gain	0		
Impedance	75		
Polarization	H	H/V	V
Packing dimensions (10 u.)	490 x 220 x 600	650 x 280 x 320	800 x 200 x 250
Weight (10 u.)	7,2	6,8	6,1

rhombus Series

OPTIMISED DIGITAL TV HDTV ANTENNA with high gain and excellent mechanical resistance.

APPLICATION

Digital and analog TV reception for community and individual antenna installations, some models totally adapted to the LTE environment.





CHARACTERISTICS

- Modern, optimised design to achieve optimum gain/size ratio.
- Active/passive dipole.
- Self-adapting: provides a constant, balanced signal, minimising loss and maximising adaptation.
- Lightweight and robust, designed with state-of-the-art technology to guarantee an excellent response and a long lifetime.
- High quality plastic with special UV protection.
- Easy installation, in just 3 clicks, no tools needed.
- Compact, small-sized single-unit packing.
- Simple, ergonomic mast fixing system to guarantee secure mounting.

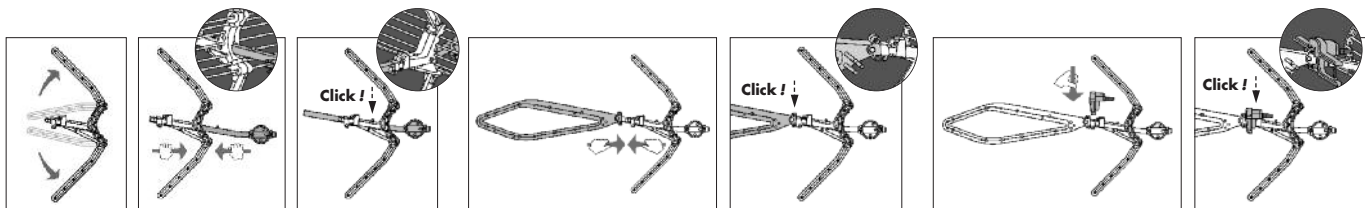

SIGNAL
RECEPTION



MODEL	rhombus 	rhombus 5 	rhombus P 	rhombus 5 P 	rhombus C69	rhombus C69 5	rhombus C69P	rhombus C69P 5
Reference	84390	84391	84393	84392	84398	84399	84396	84400
Channels	21-60				21-69			
Gain	17 (34 active)		17		17 (34 active)		17	
Power supply	12-24		—		12-24		—	
Current drawn					45			
Horizontal opening angle at -3dB					36			
Back-to-front ratio					>24			
Length					980			
Windload	130 km/h				65			
	160 km/h				92			
Units per package	1	5	1	5	1	5	1	5
Package dimensions	600 x 375 x 170	600 x 400 x 690	600 x 375 x 170	600 x 400 x 690	600 x 375 x 170	600 x 400 x 690	600 x 375 x 170	600 x 400 x 690
Operating temperature range	-20 ÷ 60							
Weight	2,15	10	2,15	10	2,15	10	2,15	10



ACTIVE/PASSIVE
DIPOLE- 100%
SEALED



SELF-ADAPTING



LTE MAXIMUM
PROTECTION



HIGH
RESISTANCE



EASY
INSTALLATION



COMPACT
SINGLE-UNIT
PACKAGING



LIGHTWEIGHT,
BUT ROBUST



NEW MAST
FIXING SYSTEM

GAIN RESPONSE

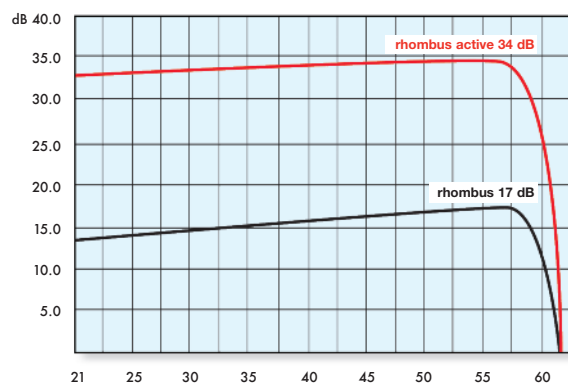

Di@na Series

Di@na is a carefully designed antenna, which construction cares even the smallest details, maintaining the symmetry in all components that minimizes internal reflections and maximize performance.

APPLICATION

Digital and analogue TV reception.

CHARACTERISTICS

- Pre-assembled for easy set-up.
- The reflector and dipole have been designed for a higher front-to-back ratio.
- Long-life antenna due to its aluminium and ABS plastic construction.
- Ergonomic design for a tool-free installation.
- Suitable for horizontally or vertically polarised channels, maintaining its water-proofing in any position.
- It has an "F" connector with protection cover.
- In case of low coverage areas, the **Di@na @ktive** model incorporates a dipole that improves the reception margin in the installation.



SIGNAL RECEPTION

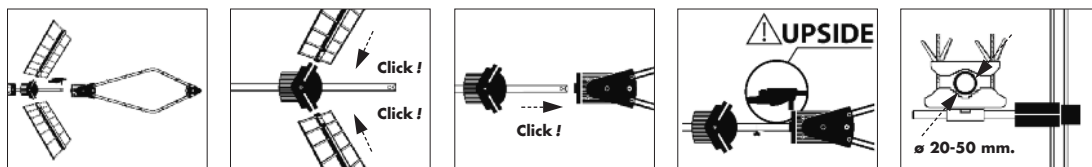

Supply voltage	12 ÷ 24 Vdc
Current drawn	25 mA

MODEL		Di@na	Di@na 6U	Di@na @ktive	Di@na @ktive 6U
Reference		84375	84377	84387	84386
Channels		21 ... 69			
Gain	dB	16,5		32	
Impedance	Ω	75			
Return losses	dB	15			
Horizontal opening angle at -3dB	$^\circ$	33			
Length	mm	1.128			
Windload	130 km/h	71			
	160 km/h	98			
Units per package		1	6	1	6
Packing Dimensions	mm	740 x 330 x 180	760 x 340 x 660	740 x 330 x 180	760 x 340 x 660
Weight	Kg	2	12	2	12

GAIN RESPONSE

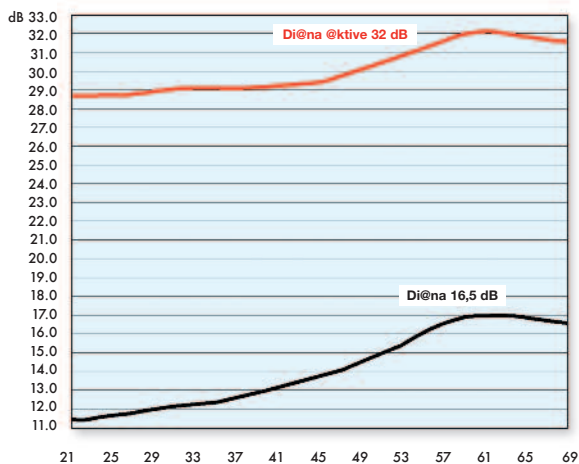

HORIZONTAL OPENING DIAGRAM

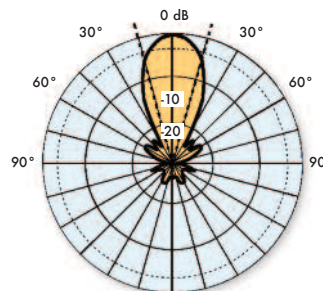

EASY INSTALLATION



LIGHTWEIGHT, BUT ROBUST



HIGH RESISTANCE

Di@na X-trem Series

Rhombus shape antenna that offers maximum gain (18,5 dBi). Solves the DTT reception problems in overlapping coverage areas.

APPLICATION

Digital TV reception.

CHARACTERISTICS

- Pre-assembled for easy set-up.
- The reflector and dipole have been designed for a higher front-to-back ratio.
- Long-life antenna due to its aluminium and ABS plastic construction.
- Ergonomic design for a tool-free installation.
- Suitable for horizontally or vertically polarised channels, maintaining its waterproofing in any position.
- It has an "F" connector with protection cover.



SIGNAL
RECEPTION

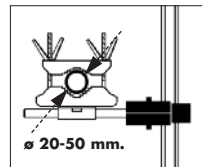
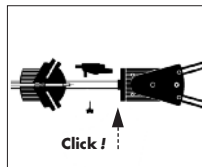
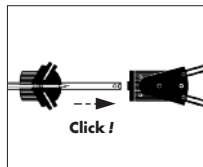
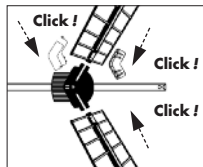
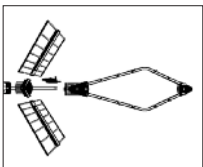

MODEL		Di@na X-trem
Reference		34388
Channels		21 ... 69
Gain	dB	18,5 (34 with @ktive dipole)
Impedance	Ω	75
Return losses	dB	15
Horizontal opening angle at -3 dB	$^\circ$	22
Length	mm	1.190
Windload	130 km/h 160 km/h	N
		122 153
Units per package		1
Packing Dimensions	mm	1000 x 480 x 160
Weight	Kg	2,5

* Improves the factor of merit in low signal areas.

GAIN RESPONSE

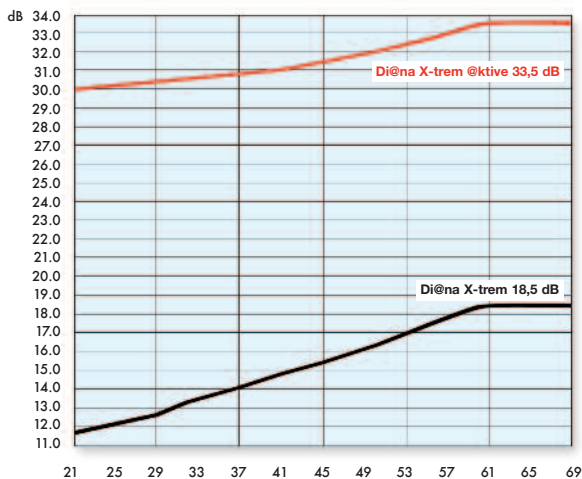

RADIATION DIAGRAM

Gain 18 dBi

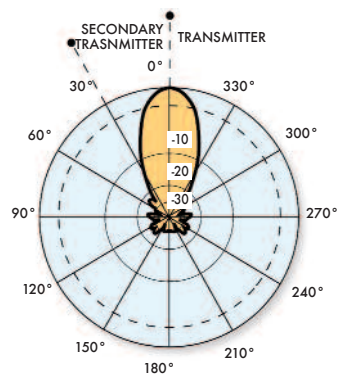

EASY INSTALLATION



LIGHTWEIGHT, BUT ROBUST



HIGH RESISTANCE

@ktive

DESCRIPTION

UHF Preamplifier designed for TV reception in weak signal areas.

CHARACTERISTICS

- Low noise figure
- Protected against electric discharge
- High output level
- Designed with SMD technology
- Embedded shielding by design
- Excellent adaptation to input and output impedance
- Especially designed for Di@na antenna



DI@NA ANTENNA + @ktive

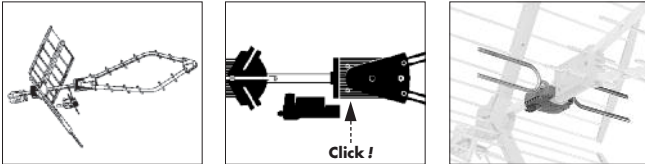

Supply voltage	12 ÷ 24 Vdc
Current drawn	25 mA
Operating temperature range	-20 ÷ 60° C

MODEL		@ktive
Reference		84385
Band covered	MHz	470 ÷ 862
Minimum input level for S/N = 30 dB, analogue TV	dBµV	34
Minimum input level for S/N = 19 dB, digital TV	dBµV	23,5
Input impedance	Ω	300
Maximum output level DIN 45004B (-60 dB)	dBµV	102
Output impedance	Ω	75
Output connector		F (f)
Gain	dB	18 (470 MHz) / 15 (862 MHz)
Noise figure	dB	2
Packing dimensions	mm	424 x 200 x 92
Weight	Kg	0,250

APPLICATION EXAMPLES

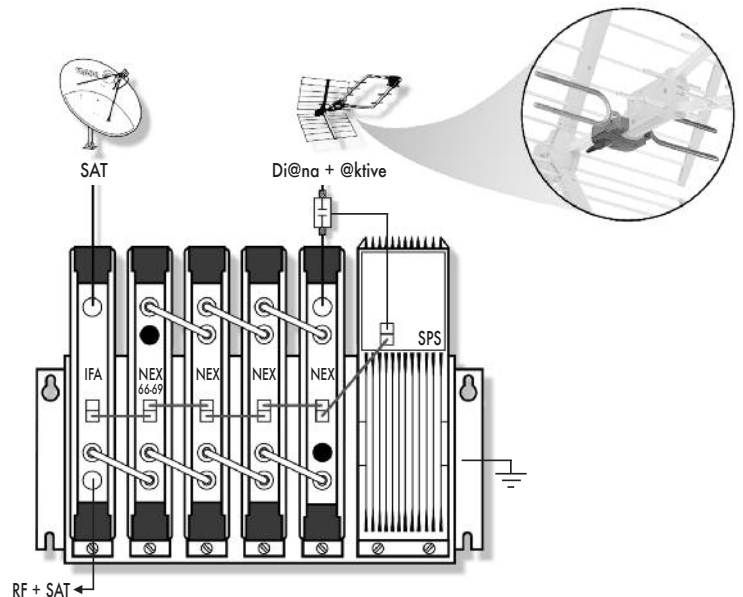
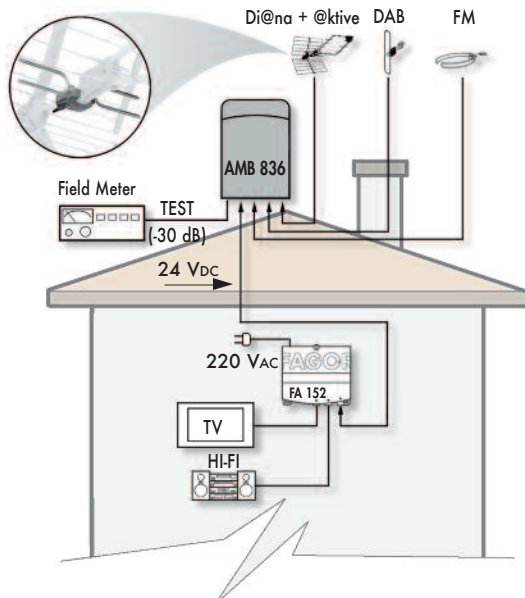

Digit Series

UHF antenna which offers high gain and great mechanical resistance.

APPLICATION

Digital and analogue TV reception.

CHARACTERISTICS



- Compact and resistant with strong, undeformable clip.
- It has stud bolts to avoid being lost or dropped during assembly operations.
- Immune to most interference generated by different sources.
- It has an F connector which gives it high shielding.
- Digit 25 LTE: Designed for the digital dividend.

- DIGIT 45, DIGIT 75: The aluminium reflectors are supplied pre-assembled to make their installation easier, with no need for tools.

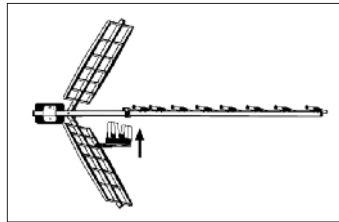
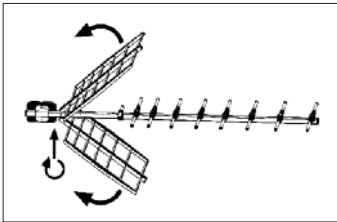

SIGNAL RECEPTION



MODEL	Digit 25 F	Digit 25 LTE 	Digit 25 LTE 6u 	Digit 45	Digit 45 6 u	Digit 75	
Reference	84384	84374	84366	84380	84381	84382	
Channels	21 ... 69	21 ... 60		21 ... 69			
Gain	dB	13		14		15,5	
Impedance	Ω	75					
Return losses	dB	10					
Front-to-back ratio	dB	24		25			
Horizontal opening angle at -3 dB	$^{\circ}$	36		35		32	
Length	mm	1006		1045		1350	
Windload	130 km/h 150 km/h	N	65 92	70 97		80 125	
Units per package		6	1	6	1	6	1
Packing dimensions	mm	570 x 380 x 85	1015 x 350 x 65	1030 x 370 x 355	1080 x 480 x 100	1080 x 480 x 400	1370 x 460 x 95
Weight	Kg	1,58	1,45	10,7	1,9	12	2,2

HORIZONTAL OPENING DIAGRAM

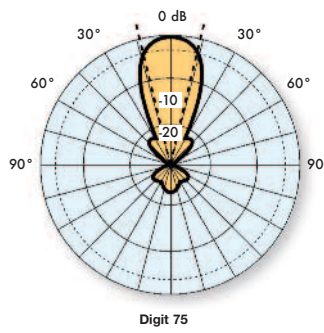
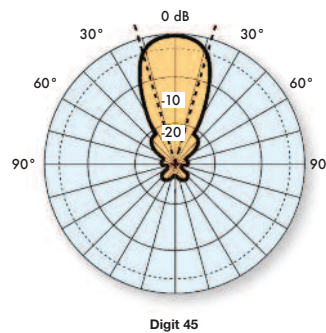
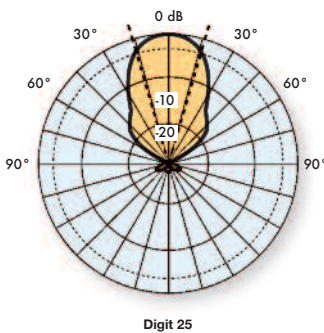

GAIN RESPONSE

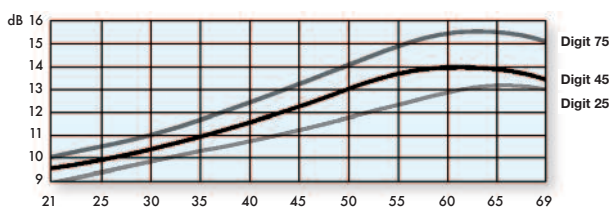

NOMAD Series

Antenna for digital terrestrial TV reception.

APPLICATION

Suitable for signal reception in individual systems. Its lightness, ease of assembly and strength also make it suitable as a portable antenna (in caravans or similar).

CHARACTERISTICS

- Incorporates a shielded low noise figure preamplifier and high output level.
- Multiband amplification (FM / BIII-DAB / UHF).
- Compatible with HDTV.
- Waterproof and UV resistant plastic housing.
- Easy to assemble without tools.
- Low visual impact.
- Compact and light packaging.



MODEL	NOMAD	
Reference	84352	
Band coverage	FM / BIII / UHF	
Output frequency	MHz	88-108 / 174-230 / 470-862
Gain	dB	21 / 27 / 30
Max. output level	dBμV	105*
Output impedance	Ω	75
Noise figure	dB	3
Power supply	Vdc	12
Consumption	mA	50
Packing dimensions	mm	350 x 90 x 350
Operating temperature range	°C	-20 ÷ 60
Weight	Kg	1,4

* (DIN 45004 B (-60dB)).

SIGNAL RECEPTION

LTE INDOOR ANTENNA

Reception of terrestrial TV and radio programs, up to 36 dB of amplification, expanding reception range and receiving more signals over longer distance.

CHARACTERISTICS

- LTE ready.
- Plug & play.
- Gain regulation.
- Flat design to fit easily in home decor.
- Incorporates mains switch-off.
- Eco-design: meet ErP.

FLAT Series

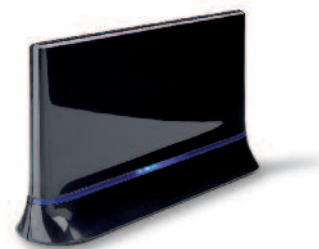

MODEL	FLAT 100 LTE		
Reference	84300		
Band	VHF	UHF	
Frequency range	MHz	174÷230	470÷770 771÷790
Gain	dB	25	20
Noise figure	dB	4,5	
Gain control	dB	22	—
Gain rejection		—	824-862: 15dB Max. 863-1000: 5dB Max.
Impedance	Ω	75	
Packing dimensions	mm	292 x 171 x 98	
Operating temperature range	°C	-20~+40	
Weight	Kg	0,7	

DISHES

Satellite dishes manufactured of electro zinc-coated steel with a polyester coating ensuring high level of resistance to weather conditions.

APPLICATION

Suitable for community and individual Satellite TV installations. Available a wide range of diameters according to the size of the installation.

CHARACTERISTICS

- The parabolic reflectors are designed to achieve high gain.
- Pole or wall mounting.



SIGNAL
RECEPTION

MODEL		PO 064	PO 081	DPO 105*
Reference		86064	86081	86105
Diameter	cm	51 x 57	73 x 80	91 x 100
Focal distance	cm	32,7	46,8	58,3
Type of reflector		Offset		
Material		Electro zinc-coated steel		
Coating		Polyester		
Type of fixing		Floor / Wall / Pole		Mast
Mast diameter	mm	30 ÷ 60	30 ÷ 60	30 ÷ 60
Elevation	°	17 ÷ 55	17 ÷ 55	- 5 ÷ 82
Offset angle	°	19		
Azimuth	°	180		
LNB fixing Ø	mm	25 ÷ 40		
Frequency range	GHz	10 ÷ 12,75		
Gain (11,7 Ghz)	dB	35	38	39,2
Efficiency	%	>60		
Beam width (- 3 dB)	°	2,8	2,4	2,1
F/D relation		0,64		
Wind speed		Operating: up to 100 km/h Maximum: up to 130 km/h		
Packing dimensions	mm	610 x 610 x 110	830 x 840 x 120	1020 x 1000 x 120
Weight	Kg	5	9	10

* Pole not included. See accessories.

SATELLITE DISH + LNB Kits

Kits composed of Offset satellite dishes manufactured of electro-zinc coated steel with a polyester coating and LNB converters.

APPLICATION

Suitable for community and individual satellite TV installations.

CHARACTERISTICS

- The parabolic reflectors are designed to achieve high gain, guaranteeing great strength and mechanical resistance.
- Easy fitting system.
- Universal LNB: low noise figure and high gain.



MODEL		KIT PO 064	KIT PO 081
Reference		86164	86181
Packing dimensions (4 u.)	mm	630 x 605 x 113	850 x 844 x 125
Weight (4 U.)	Kg	14,7	17
SATELLITE DISH			
Diameter	cm	60 x 65	73 x 79
Focal distance	cm	32,7	53
Type of reflector		Offset	
Material		Electro zinc-coated steel	
Coating		Polyester	
Mast diameter	mm	30 ÷ 60	
Elevation		10° ÷ 90°	
Offset angle		28°	26°
Azimuth		360°	
Frequency	GHz	10,7 ÷ 12,75	
Gain @10,7 GHz	dBi	35,2	35.9
Gain @11,7 GHz	dBi	36,1	37.4
Gain @12,7 GHz	dBi	37	38.0
Efficiency	%	> 70	
F/D relation		0,64	
Wind speed		Operating: up to 130 Km/h Maximum: up to 150 Km/h	
Universal LNB			
Number of inputs		1	
Polarity		VL, HL, VH, HH	
Input frequency	GHz	Low Band 10,7 ÷ 11,7 High Band 11,7 ÷ 12,75	
Oscillator frequency	GHz	Low Band 9,75 High Band 10,60	
Output frequency range	MHz	Low Band 950 ÷ 1950 High Band 1100 ÷ 2150	
Noise figure at 20° C	dB	0,2	
Conversion gain	dB	50 ÷ 65 (typical 55)	
Output level (1 dB of compression)	dB	> 0 (typical 5)	
Power supply	V	11,5 ÷ 14 (V); 16 ÷ 19 (H)	
22 KHz tone		0,6 Vpp ± 0,2 for High band	
Consumption	mA	< 200	
Output connectors		F (f)	
Operating temperature range	°C	- 25 ÷ + 60	

LNB Series

Universal low noise block converters suitable for any offset satellite dish.

CHARACTERISTICS

- Stand out for their low noise figure and high gain which together with Offset type satellite dishes make it possible to obtain merit factors ideal for collective installations.
- Big Cross Polarity Rejection: 25 dB.



MODEL	LNB 201 Universel	LNB 222 TWIN	LNB 244 QUAD	LNB 248 Octo
Reference	86129	86132	86134	86138
Number of outputs	1	2	4	8
Polarity	VL, HL, VH, HH			
Input frequency	GHz	Low band 10,7 ÷ 11,7 High band 11,7 ÷ 12,75		
Oscillator frequency	GHz	Low band 9,75 ± 2 MHz High band 10,60 ± 2 MHz		
Output frequency range	MHz	Low band 950 ÷ 1950 High band 1100 ÷ 2150		
Noise figure at 20° C	dB 0,2			
Cross polarity rejection	dB 25			25
Conversion gain	dB 50 ÷ 65 (typical 58)			
Output level (1 dB of compression)	dBm >0			
Power supply	V 11,5 ÷ 14 (V); 16 ÷ 19 (H)			11,5 ÷ 19
22 KHz tone	0,6 Vpp ± 0,2 for High band			—
Consumption	mA <200	<300		215
Output connectors	F (f)			
Operating temperature range	°C - 25 ÷ + 60			
Packing dimensions	mm 85 x 110 x 60	100 x 125 x 60	120 x 125 x 65	90 x 110 x 130
Weight	Kg 0,110	0,190	0,235	0,315

MODEL	LNB 181 Monoblock Single	LNB 182 Monoblock TWIN	LNB 184 Monoblock QUAD	LNB 204 Quattro
Reference	86135	86136	86137	86131
Number of outputs	1	2	4	
Polarity	VL, HL, VH, HH Astra - Hotbird separate 6°			VL HL VH HH
Input frequency	GHz	Low band 10,7 ÷ 11,7 High band 11,7 ÷ 12,75		
Oscillator frequency	GHz	Low band 9,75 ± 2 MHz High band 10,60 ± 2 MHz		
Output frequency range	MHz	Low band 950 ÷ 1950 High band 1100 ÷ 2150		
Noise figure at 20° C	dB 0,2			
Cross polarity rejection	dB 25			—
Conversion gain	dB 50 ÷ 65 (typical 58)			
Output level (1 dB of compression)	dBm >0			
Power supply	V 11,5 ÷ 14 (V); 16 ÷ 19 (H)			11,5 ÷ 19
22 KHz tone	0,6 Vpp ± 0,2 for High band			—
Consumption	mA <200			
Output connectors	F (f)			
Operating temperature range	°C - 25 ÷ + 60			
Packing dimensions	mm 110 x 90 x 130	110 x 120 x 130	110 x 120 x 130	110 x 125 x 60
Weight	Kg 0,315	0,555	0,570	0,235

SCR Series

Low Noise Block converter that supports the SCR protocol.

APPLICATION

The SCR output let send signal up to 4 user SCR compatible set top boxes. The legacy output works like a single standard universal converter for a classic set top box.

CHARACTERISTICS

- Low noise figure.
- 1 SCR output for 4 users and Legacy output for a user.



MODEL		LNB SCR	
Reference		86139	
Outputs		SCR output (4 users)	Universal (Legacy) output
Input frequency	GHz	Low band 10,7 ÷ 11,7 High band 11,7 ÷ 12,75	
Oscillator frequency	GHz	Low band 9,75 ± 2 MHz High band 10,60 ± 2 MHz	
Output frequency range		1: 1210 MHz 2: 1420 MHz 3: 1680 MHz 4: 2040 MHz	950 - 2150 MHz
LO frequency stability (-20°C - 60°C)		± 3MHz	
LO phase noise		-60 dBc /Hz (@ 1KHz offset) -75 dBc /Hz (@ 10KHz offset) -95 dBc /Hz (@ 100KHz offset)	
Noise figure	dB	0,7	
Conversion gain	dB	50,5 (min) ÷ 69 (max)	
Cross polarization isolation	dB	20 (min)	
Polarization switching voltage		DiSEqC-ST command	Vertical: 11,5-14 V Horizontal: 16-19 V
DC current consumption	mA	330 (max)	
Operating temperature range	°C	-20 ÷ 60	
Packing dimensions	mm	73 x 63 x 180	
Weight	Kg	0,254	

SIGNAL RECEPTION

1st IF SAT LINE AMPLIFIER

1st IF SAT signal line amplifier.

APPLICATION

Suitable for digital or analogue TV installations.

CHARACTERISTICS

- Offers a linear response, up to 2150 MHz.
- Transparent for 22 KHz switching signal control.
- Remote powered through the coaxial cable.

Individual installation application example

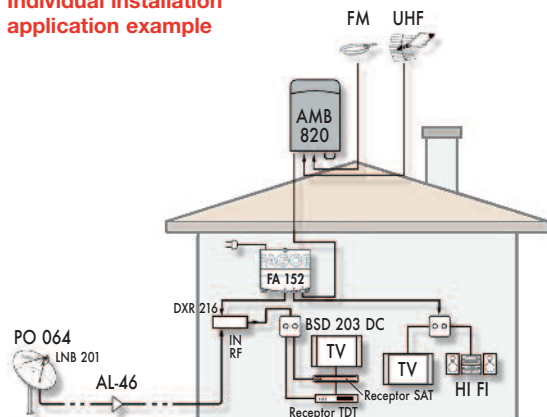

AL 46



MODEL		AL 46
Reference		86246
Type of connector		F (f)
Frequency range	MHz	950 ÷ 2300
Gain (950 ÷ 2300 MHz)	dB	15 ÷ 18
Noise figure	dB	7
Max. output level (-35 dB) dBµV		109
Current drawn	mA	50
DC pass (max.)	A	1
Supply voltage	Vdc	15 ± 3
Packing dimensions	mm	80 x 20 x 25
Weight	Kg	0,1

STT 8000 Series

Digital/digital transmodulation of a transponder on the 1st IF Satellite band (950 ÷ 2150 MHz) modulated in QPSK or 8PSK to a channel modulated in COFDM on the 47 ÷ 862 MHz band. De-encryption of one or more services when CAM+Smart Card are inserted (CI model).

APPLICATION

8000 Series XPSK/COFDM processing. It allows receiving Satellite TV programmes in the original format (SD, HD, Subtitling...) directly through DTT receivers embedded in SD, HD Ready and Full HD screens or through a standalone DTT receiver.

CHARACTERISTICS

- Selection of a DVB-S/S2 channel between 950 and 2150 MHz.
- Demodulation, detection and correction of the errors of the received signal.
- Output signal with MER in optimum quality level for signal distribution.
- LNB control 22 KHz 13/17 V or DiSEqC 1.2.
- Conversion of encrypted services into free services through the corresponding CAM (CI model).
- Selection of services of interest at the output, adapting the transport stream.
- Indication of the occupancy level of each service and the overall multiplex selected.
- Assignment of LCN (channel number) services to facilitate the automatic tuning of the STB.
- Processing of transport stream. Regeneration of tables, time, stamping correction, edition of programs...
- Regenerates the NIT table at individual and installation level.
- Edition of the name and network IDs.
- Software upgradeable with MCU / LPU.



Supply voltage	V	5	12	17	30
Current drawn STT / STT-CI	mA	720 / 850	375	20	2
Total power (CI)	W	9,5 (without CAM)			
Operating temperature range		0 ÷ 45° C			

MODEL		STT 8000	STT-CI 8000
Reference		08280	08281
INPUT			
Frequency band	MHz	950 ÷ 2150	
Input level	dBµV	40 ÷ 86	
Modulation type		QPSK - 8PSK	
Symbol rate	Mbaud	4 ÷ 45 DVB-S, 10÷ 30 DVB-S2	
LCN insertion		yes	
Through losses	dB	< 1,5	
LNB control		22 KHz 13/17 V or DiSEqC 1.2	
OUTPUT			
Frequency band	MHz	47 ÷ 862	
COFDM modulation type		2K; 8K	
Modulation parameters		DVB-T	
Output constellation		QPSK, 16 QAM, 64 QAM	
MER	dB	38	
Output level	dBµV	80	
Regulation of output level	dB	15	
CAM module (not included)		—	According to Norm DVB-CI EN 50221
CAM module current drawn		—	5V-250 mA (+1,25 W)
Programming		UCF 300 / PC (with MCU / LPU 8000)	
Packing dimensions	mm	265 x 195 x 40	
Weight	Kg	1,33	

HEADENDS

TTT 8000 Series

Regeneration of an entire DVB-T multiplex, correcting the transport-stream errors, with or without Common Interface. De-encryption of one or more services when CAM and card are inserted (CI model).

APPLICATION

Its main function is to receive a DVB-T transponder, select certain services - including conditional access services, opening rights (model TTT-CI) - and modulating them in a DVB-T transponder to the desired frequency and with an optimal MER for distribution.

CHARACTERISTICS

- Selection of a COFDM channel between 174 and 862 MHz.
- Demodulation, error detection and correction of the received signal.
- MER regeneration of origin in an optimum quality level for signal distribution.
- COFDM modulation signal at the output channel.
- Conversion of encrypted services to free services through the corresponding CAM (Ci model).
- Selection of services of interest at the output, adapting the transport stream.
- Indication of the occupancy level of each service and the overall multiplex selected.
- Assignment of LCN (channel number) services to facilitate the automatic tuning of the STB.
- Processing of transport stream. Regeneration of tables, time, stamping correction, edition of programs...
- Regenerates the NIT table at individual and installation level.
- Edition of the name and network IDs.
- Software upgradeable with MCU / LPU.

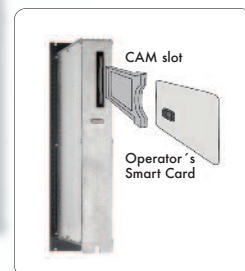

Supply voltage	V	5	12	30
Current drawn TTT / TTT-CI	mA	600 / 730	375	2
Total power (CI)	W	8 (without CAM)		
Operating temperature range		0 ÷ 45° C		

MODEL	TTT 8000	TTT-CI 8000
Reference	08290	08291
INPUT (COFDM)		
Frequency band	MHz 174 ÷ 862 ($\Delta = 166$ KHz)	
Input level	dB μ V 40 ÷ 90	
CONDITIONAL ACCESS	NO	Yes EN 50221 (DVB-CI)
TRANSPORT STREAM PROCESSING		
PCR correction	Yes	
Table processing	PAT, CAT, PMT, SDT, NIT, EIT, BAT, TDT/TOT	
LCN insertion	Yes	
DVB-T (IN and OUT) MODULATION		
Standard	EN 300 744	
COFDM modulation type	2K, 8K	
Constellation	QPSK, 16-QAM, 64-QAM	
Code Rate	1/2, 2/3, 3/4, 5/6, 7/8	
Guard Interval	1/4, 1/8, 1/16, 1/32	
Bandwidth	MHz 7, 8	
MER	dB 38	
RF OUTPUT		
Frequency band	MHz 50.5 ÷ 858 ($\Delta = 166$ KHz)	
Output level	dB μ V 65 ÷ 80 ($\Delta = 0.5$ dB μ V)	
Through losses	dB < 1,5	
Spurious in band	dBc < - 54	
CAM module current drawn (not included)	5V-250 mA (+ 1,25W)	
Programming	UCF 300 / PC (with MCU / LPU 8000)	
GENERAL		
Packing Dimensions	mm 265 x 195 x 40	
Weight	Kg 1.33	

Abbreviations: PAT: Program Association Table
CAT: Conditional Access Table
PMT: Program Mapping Table
SDT: Service Description Table

NIT: Network Information Table
EIT: Event Information Table
BAT: Bouquet Association Table
TDT/TOT: Offset Time Table

SCT 8000 Series

Module for processing a DVB-S/S2 multiplex, selection of services of interest with / without Conditional Access and conversion to a channel under DVB-C standard. It corrects the transport stream errors. De-encryption of one or more services when CAM and card are inserted (CI model).

APPLICATION

The main function of the SCT 8000 is to receive a DVB-S/S2 transponder, select certain services - including conditional access services, opening rights (SCT-CI model) - and modulating them into a DVB-C transponder to the desired frequency and with an optimal MER for distribution.

CHARACTERISTICS

- Selection of a DVB-S/S2 channel between 950 and 2150 MHz.
- Demodulation, detection and correction of the errors of the received signal.
- Output signal with MER in optimum quality level for signal distribution.
- LNB control 22 KHz 13/17 V or DiSEqC 1.2.
- Conversion of encrypted services into free services through the corresponding CAM (CI model).
- Selection of services of interest at the output, adapting the transport stream.
- Indication of the occupancy level of each service and the overall multiplex selected.
- Assignment of LCN (channel number) services to facilitate the automatic tuning of the STB.
- Processing of transport stream. Regeneration of tables, time, stamping correction, edition of programs...
- Regenerates the NIT table at individual and installation level.
- Edition of the name and network IDs.
- Software upgradeable with MCU / LPU.

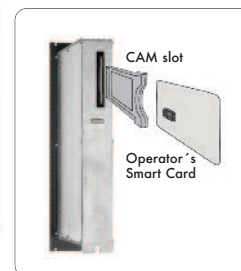

Supply voltage	V	5	12	17	30
Current drawn SCT /SCT-CI	mA	720 / 850	375	20	2
Total power (CI)	W	9,5 (without CAM)			
Operating temperature range		0 ÷ 45° C			

MODEL	SCT 8000	SCT-CI 8000
Reference	08270	08271
INPUT		
Frequency band	MHz 950 ÷ 2150	
Input level	dBµV 40 ÷ 86	
Modulation type	QPSK, 8PSK (DVB-S/S2)	
Symbol rate	DVB-S: 4 ÷ 45 / DVB-S2: 10 ÷ 30	
Through losses	1,5	
LNB control	22 KHz 13/17 V or DiSEqC 1.2	
CONDITIONAL ACCESS	—	EN 50221 (DVB-CI)
TRANSPORT STREAM PROCESSING		
PCR correction	Yes	
Table processing	PAT, CAT, PMT, SDT, NIT, EIT, BAT, TDT/TOT	
LCN insertion	Yes	
OUTPUT QAM MODULATION		
Modulation parameters	DVB-C	
Symbol rate	Mbaud 1 ÷ 6,96	
QAM order	16, 32, 64, 128, 256	
MER	dB 40	
Through losses	dB 1,5	
RF OUTPUT		
Frequency band	MHz 50,5 ÷ 858 (Δ = 166 KHz)	
Output level	dBµV 65 ÷ 80 (Δ = 0,5 dBµV)	
Through losses	dB 1,5	
Spurious in band	dBc - 54	
CAM module current drawn (not included)	5V-250 mA (+ 1,25W)	
Programming	UCF 300 / PC (WITH MCU / LPU 8000)	
GENERAL		
Packing Dimensions	mm 265 x 195 x 40	
Weight	Kg 1,33	

Abbreviations: PAT : Program Association Table
CAT : Conditional Access Table
PMT : Program Mapping Table

SDT : Service Description Table
NIT : Network Information Table
EIT : Event Information Table

BAT : Bouquet Association Table
TDT/TOT : Offset Time Table

TCT 8000 Series

Module for processing a DVB-T multiplex, selection of services of interest with / without Conditional Access and conversion to a channel under DVB-C standard. It corrects the transport stream errors. De-encryption of one or more services when CAM and card are inserted (CI model).

APPLICATION

The main function of the TCT 8000 is to receive a DVB-T transponder, select certain services - including conditional access services, opening rights (TCT-CI model) - and modulating them into a DVB-C transponder to the desired frequency and with an optimal MER for distribution.

CHARACTERISTICS

- Selection of a DVB-T channel between 149 and 862 MHz.
- Demodulation, detection and correction of the errors of the received signal.
- Output signal with MER in optimum quality level for signal distribution.
- QAM signal modulation in the desired output channel.
- Conversion of encrypted services into free services through the corresponding CAM (CI model).
- Selection of services of interest at the output, adapting the transport stream.
- Indication of the occupancy level of each service and the overall multiplex selected.
- Assignment of LCN (channel number) services to facilitate the automatic tuning of the STB.
- Regenerates the NIT table at individual and installation level.
- Edition of the name and network IDs.
- Software upgradeable with MCU / LPU.

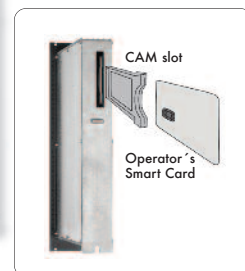

Supply voltage	V	5	12	30
Current drawn TCT / TCT-CI	mA	580 / 710	340	2
Total Power (CI)	W	8 (without CAM)		
Operating temperature range		0 ÷ 45° C		

MODEL	TCT 8000	TCT-CI 8000
Reference	08260	08261
RF INPUT		
Frequency band	174 ÷ 862 (Δ = 166 KHz)	
Input level	40 ÷ 90	
CONDITIONAL ACCESS	—	EN 50221 (DVB-CI)
TRANSPORT STREAM PROCESSING		
PCR correction	Yes	
PTS correction	Not processed	
Table processing	PAT, CAT, PMT, SDT, NIT, EIT, BAT, TDT/TOT	
LCN insertion	Yes	
OUTPUT QAM MODULATION		
Modulation parameters	DVB-C	
Symbol rate	1 ÷ 6,96	
Order QAM	16, 32, 64, 128, 256	
MER	40	
Through losses	1,5	
RF OUTPUT		
Frequency band	50,5 ÷ 858 (Δ = 166 KHz)	
Output level	65 ÷ 80 (Δ = 0,5 dBμV)	
Through losses	< 1,5	
Spurious in band	< - 54	
CAM module current drawn (not included)	5V-250 mA (+ 1,25W)	
Programming	UCF 300 / PC (with MCU / LPU 8000)	
GENERAL		
Packing Dimensions	265 x 195 x 40	
Weight	1,33	

DEN 8000

The DEN 8000 encoder, modulates the content of 4 analogue audio/video signals to a DVB-ASI format.

APPLICATION

It is used to watch the content of several analogue sources, such as surveillance cameras or DVD players, among others, on a TV equipped with a DTT receiver.

CHARACTERISTICS

- Multiplexer function for up to 4 analogue A/V sources (PAL, NTSC).
- MPEG-2 MP@ML output video encoding, bit rate 1-15Mbps.
- MPEG-1 Layer 1, Layer 2 audio encoding.
- Programming via front panel (keyboard + LCD display) or PC (local or remote).
- Mountable in 19" rack.
- Includes:
 - 4 x 3RCA-3BNC cables for 4 analogue A/V sources.
 - 1 x BNC-F(m) cable for one COFDM output.
 - 1 x user's manual.
 - 1 x 230Vac cable.



Supply voltage	90 ÷ 250 V
Power consumption	25 W
Operating temperature range	0 ÷ 45° C

MODEL		DEN 8000
Reference		08200
INPUT		
Video format		CVBS
Video Standard		PAL, NTSC
Video connectors		BNC, 75 Ohm
Input audio		1xStereo / 2xMono
Audio connectors		2xBNC, 600 Ohm
OUTPUT		
Standard		DVB-ASI
ASI connectors		2xBNC, 75 Ohm
Video encoding		MPEG-1, MPEG-2 MP@ML
Bit Rate video	Mbps	1-15
Video format		Full D1, Half D1, SIF
Audio encoding		MPEG-1 Layer1, Layer 2
Sample Rate audio	kHz	32, 44.1, 48
Packing dimensions	mm	580 x 580 x 135
Weight	kg	6,2

HEADENDS

DMT 8000

APPLICATION

The DMT 8000 digital modulator modulates the incoming MPEG-2 TS in DVB-ASI signal into a COFDM channel.

CHARACTERISTICS

- Indication of residual channel capacity.
- Regeneration of the Network Information Table (NIT), either locally for each module or for the entire installation.
- TS processing with LCN insertion, PCR restamping and TS remapping.
- Selection of programmes.



Supply voltage	V	5	12	17	30
Current drawn (7 W)	mA	800	360	0	2
Operating temperature range					0 ÷ 45° C

MODEL		DMT 8000
Reference		08201
INPUT		
Standard		DVB-ASI
Package length		Automatic detection 188/204 Bytes
Input connector		F(f)
TS PROCESSING		
LCN insertion		yes
Operating modes		Transparent/Re-multiplexer
OUTPUT		
Standard		DVB-T
Frequency band	MHz	47-862
COFDM modulation		2K/8K
Constellation type		QPSK/16-QAM/64-QAM
MER	dB	38
Output level	dBµV	80
Output level adjustment	dB	15
Programming		UCF 300 / PC (with MCU / LPU 8000)
Packing dimensions	mm	265x 195 x 40
Weight	Kg	1,33

ACM 8000

APPLICATION

Modulates the incoming MPEG-2 TS in DVB-ASI signal into a DBV-C channel.

CHARACTERISTICS

- Indication of residual channel capacity.
- Regeneration of the Network Information Table (NIT), either locally for each module or for the entire installation.
- TS processing with LCN insertion, PCR restamping and TS remapping.
- Selection of programmes.



Supply voltage	V	5	12	17	30
Current drawn (6 W)	mA	550	225	0	2
Operating temperature range	0 ÷ 45° C				

MODEL	ACM 8000	
Reference	08202	
INPUT		
Standard	DVB-ASI	
Package length	Automatic detection 188/204 Bytes	
Input connector	F(f)	
TS PROCESSING		
LCN insertion	yes	
Operating modes	Transparent/Re-multiplexer	
OUTPUT QAM MODULATION		
Standard	DVB-C	
Symbol rate	Mbaud	1 ÷ 6,96
Order QAM	16, 32, 64, 128, 256	
MER	dB	40
Through losses	dB	1,5
RF OUTPUT		
Frequency band	MHz	50,5 ÷ 858 (Δ = 166 KHz)
Output level	dBμV	65 ÷ 80 (Δ = 0,5 dBμV)
Through losses	dB	< 1,5
Spurious in band	dBc	< - 54
Programming	UCF 300 / PC (with MCU / LPU 8000)	
GENERAL		
Packing Dimensions	mm	265 x 195 x 40
Weight	Kg	1,33

SM 8000 / SM-ST 8000

Modulator with VSB output, that allows adjacent channel operation. A programmable output channel means that the modulator can easily be inserted into the headend since it operates in any TV channel (BI,BIII, "S" Bands and UHF). The stereo model includes STEREO/DUAL signals processing.

APPLICATION

Analogue satellite TV community installations, where locally produced channels insertion is needed.

CHARACTERISTICS

- It allows audio volume adjustment to equalise them to the level of other installed programs.
- It also offers the possibility of fine tuning the output channel frequency to disperse intermodulation products in installations with many channels.
- RF output signal ON/OFF switchable for analysis and headend adjustment.
- Incorporates test bars generator.
- Output frequency shift.



Power supply voltage	V	5	12	17	30			
Model		Mono Stereo	Mono Stereo	Mono Stereo	Mono Stereo			
Current drawn	mA	270	350	400	0	0	5	5
Total power	W	5,7(Mono) – 6,3(Stereo)						
Operating temperature range		0÷45 °C						

MODEL	SM 8000	SM-ST 8000
Reference	19800	19801
Output connectors	F(f)	
Audio/video input connector	MINI DIN 5 ways	
Audio Pre-emphasis	µs	50
Video input level	Vpp	0,9 ÷ 1,25 Vpp
Audio input level	Vpp	0,5 ÷ 2,5 Vpp
Output channels VSB	MHz	47 to 862
Output level	dBµV	>90 with 15 dB regulation
Spurious in channel	dBc	>60
Spurious in band	dBc	>56
C/N ratio (3*)	dB	In channel: > 56 In band for min. output level: > 72
Carrier accuracy	KHz	±30
Carrier stability	KHz	±10
Output frequency resolution	KHz	125
Video modulation depth	%	85
Pv / Ps ratio adjustable	dB	12/16
Programming	UCF 300 / PC (with MCU / LPU 8000)	
Standard TV	PAL (B/G, I, D/K) / SECAM (L, D/K, B/G)	PAL B/G, SECAM B/G
PV / PS separation	MHz	PAL (B/G:5,5, I:6,0., D/K:6,5) / SECAM (L:6,5, D/K:6,5, B/G:5,5)
Audio output modes	Mono	Stereo / Dual switchable (A/B - B/A)
Packing dimensions	mm	265 x 195 x 40
Weight	Kg	1,33

SM-TWIN 8000 / SM-TWIN-ST 8000 SM-TWIN-W 8000

Twin modulator with VSB outputs, that allows adjacent channel operation. A programmable output channel means that the modulator can easily be inserted into the headend since it operates in any TV channel (BI,BIII, "S" Bands and UHF). The stereo model includes STEREO/DUAL signals processing.

APPLICATION

Analogue satellite TV community installations, where locally produced channels insertion is needed.

CHARACTERISTICS

- It offers the possibility of fine tuning the output channel frequency to disperse intermodulation products in installations with many channels.
- RF output signal ON/OFF switchable for analysis and headend adjustment.
- Incorporates black video generator.



Power supply voltage	V	5	12	17	30		
Model		Mono Stereo	Mono Stereo	Mono Stereo	Mono Stereo		
Current drawn	mA	570	590	330	350	0	2
Total power	W	6,9(Mono) – 7,2(Stereo)					
Operating temperature range		0÷45 °C					

MODEL	SM-TWIN 8000	SM-TWIN-ST 8000	SM-TWIN-W 8000
Reference	19802	19803	19807
Output connectors	F(f)		
Audio/video input connector	MINI DIN 5 ways		
Audio Pre-emphasis	µs	50	
Video input level (75 ohm)	Vpp	1	
Audio input level (10 Kohm)	Vpp	1	
Output channels VSB	MHz	47 to 862 (2 adjacent channels)	
Channels bandwidth		7/8 (programmable)	8
Output level	dBµV	86 with 15 dB regulation	
Spurious in channel	dBc	60	
Spurious in band	dBc	56	
C/N ratio (8 modules)	dB	In channel: 56 In band for min. output level: 63	
Carrier accuracy	KHz	±30	
Carrier stability	KHz	±10	
Output frequency resolution	KHz	125	
Video modulation depth	%	85	
Vc / Ac ratio	dB	15	
Programming		UCF 300 / PC (with MCU / LPU 8000)	
TV Standard		PAL B/G	SECAM L, SECAM D/K, PAL I, PAL D/K
Vc / Ac separation	MHz	5,5	PAL (I:6,0., D/K:6,5) / SECAM (L:6,5, D/K:6,5)
Audio output modes		Mono	Stereo / Dual switchable (A/B - B/A)
Packing dimensions	mm	265 x 195 x 40	
Weight	Kg	1,0	

RHA 8000

FM amplifier that allows radio signal FM & DAB processing in community headends.

APPLICATION

Community installations where FM & DAB radio signal distribution is needed.

CHARACTERISTICS

- Incorporates an RF signal combiner with the FM/DAB signal.
- Allows selective attenuation of the FM signals by means of its selective Notch Filters.



Supply voltage	V	5	12	17	30
Current drawn	mA	15	195	—	5
Total power	W	2,5			
Operating temperature range		0÷45 °C			

MODEL		RHA 8000
Reference		35080
FM frequency range	MHz	87.5 – 108
DAB frequency range	MHz	195 – 223
RF frequency range	MHz	47 – 862
FM gain	dB	>10
DAB gain	dB	>5
FM regulation	dB	40±2
DAB regulation	dB	20±2
Operative FM input level	dBµV	60 – 100
Operative DAB input level	dBµV	60 – 80
FM noise figure	dB	7
DAB noise figure	dB	6
FM output level DIN45004B(-35dBc)	dBµV	80
DAB output level DIN45004B(-35dBc)	dBµV	75
Selective attenuation (notch filters)	dB	>10dB (1 filter) >15dB (2 filters) >19dB (3 filters)
Through losses RF	dB	< 1,5
Packing dimensions	mm	265 x 195 x 40
Weight	Kg	1,33

SHA-SAC 8000

Broadband Amplifiers for 8000 series headends. The SHA model is a single input amplifier. The SAC Amplifier is a 4 input model to combine and amplify up to 4 frames.

APPLICATION

TV community installations, both SMATV and CATV.

CHARACTERISTICS

- They have gain regulation and a TEST output.
- Low noise figure and output level regulation.
- Screws and power supply cable included.
- Optimum frequency response.
- High dynamic threshold.



HEADENDS

		SHA		SAC	
Supply voltage	Vdc	5	12	5	12
Current drawn	mA	20 (10W)	825 (10,3W)	20 (10W)	850 (10,3W)
Total power	W	10		10,3	
Operating temperature range		0 ÷ 45° C			

MODEL		SAC 8000	SHA 8000
Reference		35081	35083
No. inputs		4	1
Frequency band	MHz	47-862	
Input impedance	Ohm	75	
Gain	dB	43	
Regulation	dB	20	
Noise figure	dB	7	
IM3 output level (-60 dBc DIN 45004B)	dBµV	120	
Output level stability	dB	± 2	
TEST output level	dB	-30	
Packing dimensions	mm	265 x 195 x 40	
Weight	Kg	1,25	

SPS 8000

The SPS 8000 model is a multi-voltage power supply that can be connected to a common power BUS shared with various power supplies.

APPLICATION

Power supply for 8000 series headends, its capacity for sharing the load makes it suitable for redundant systems.

CHARACTERISTICS

- Load Sharing technology.

RECOMMENDED LOAD LIMIT (SPS-LP): 55W

5 x STT + 2 LNB
4 x STT + 3 LNB
4 x STT + SHA + 1 LNB
4 x STT-CI + 3 LNB
4 x STT-CI + SHA + 1 LNB
7 x SM-TWIN
7 x SM-TWIN-ST
5 x SM-TWIN + SAC
5 x SM-TWIN-ST + SAC



HEADENDS

MODEL		SPS 8000				SPS-LP 8000			
Reference		68000				68001			
Input voltage	Vac	187 ÷ 264				195 ÷ 265			
Output voltages	Vdc	30	17	12	5	30	17	12	5
Max. current per output	A	0,1	0,5	4	7,5	0,03	0,2	2,5	4
Output current drawn	W	95				55			
Packing dimensions	mm	275 x 185 x 60				265 x 185 x 60			
Weight	Kg	1,5				1,4			

Example

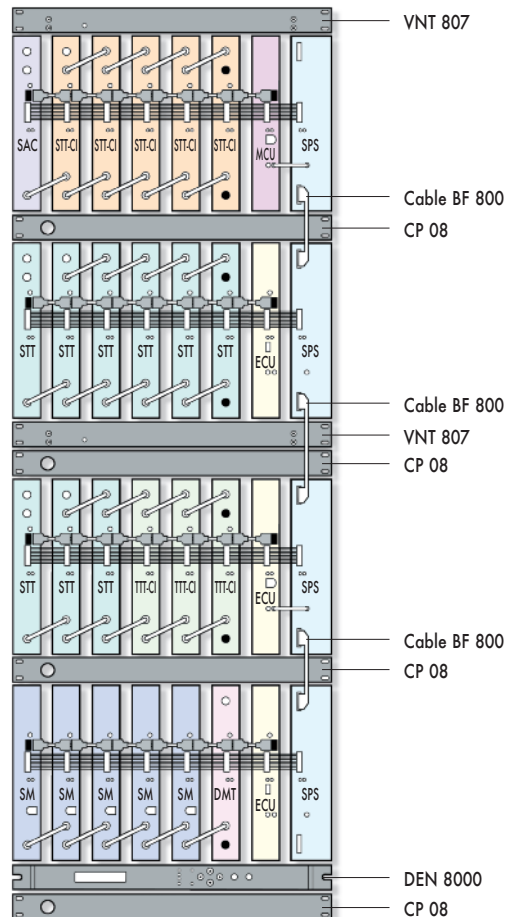

MCU 8000

Control Unit for the permanent supervision of the headend.

CHARACTERISTICS

- Configuration of the headend through the USB port on a PC.
- Upgrading of the firmware.
- Monitoring of the main parameters.
- Diagnosis of the headend.



Supply voltage	5 Vdc
Current drawn	260 mA
Operating temperature range	0 ÷ 45° C

MODEL	MCU 8000
Reference	85110
Local communication with PC	USB 2.0 12 Mbps
Com. with processing module	BUS CAN 1 Mbps
Packing dimensions	mm 270 x 195 x 40
Weight	Kg 1,50

EXTENSION UNIT FOR FRAMES

ECU 8000

Extension unit, that in combination with the Master Control Unit allows a permanent supervision of the headend (1 ECU x frame).



Supply voltage	5 Vdc
Current drawn	160 mA
Operating temperature range	0 ÷ 45° C

MODEL	ECU 8000
Reference	85114
Local communication with PC	USB 2.0 12 Mbps
Com. with processing module	CAN BUS 1 Mbps
Packing dimensions	mm 270 x 195 x 40
Weight	Kg 1,50

LPU 8000

Portable control unit for local programming via PC of a 8000 series headend.

CHARACTERISTICS

- Headend setting up through the USB port of a PC.
- Firmware updating in local mode.
- Monitoring of the main parameters.
- Local headend diagnosis.



Supply voltage	5 Vdc
Current drawn	260 mA
Operating temperature range	0 ÷ 45° C

MODEL	LPU 8000
Reference	85116
Local communication with PC	USB 2.0 12 Mbps
Com. with processing module	BUS CAN 1 Mbps
Packing dimensions mm	270 x 195 x 40
Weight Kg	1,50

Example

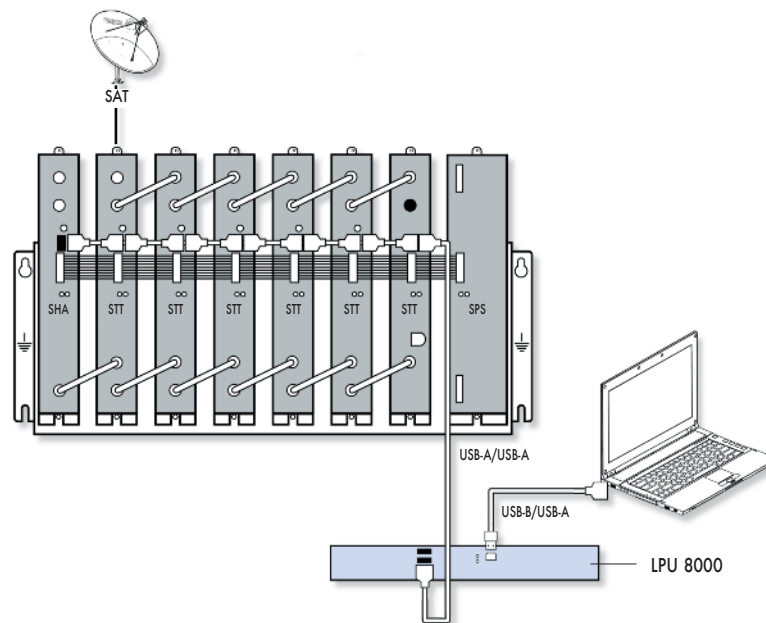

ACCESSORIES

COMMUNICATION BUS BETWEEN MODULES



APPLICATION	MOD.	REF.
8000 Series	USB 800	83811

COMMUNICATION BUS BETWEEN FRAMES



APPLICATION	MOD.	REF.
8000 Series	USB 801	83812

120 OHMS USB LOAD



APPLICATION	MOD.	REF.
8000 Series	CU 120	83813

CONTROL UNIT



APPLICATION	MOD.	REF.
8000 series & MicroMATV Evo	UCF 300	85115

POWER BUS



APPLICATION	MOD.	REF.
7 modules + power supply	BA 807	83807

RF BRIDGE



APPLICATION	MOD.	REF.
8000 series	PMD 800	83814

19" RACK BLIND COVERS



CC 08



CC FR 08

APPLICATION	MOD.	REF.
19" rack frame	CC 08 CC FR 08	83803 83816

PASSAGE COVER BETWEEN FRAMES



APPLICATION	MOD.	REF.
19" rack frame	CP 08	83817

POWER SUPPLY BUS



APPLICATION	MOD.	REF.
19" rack	BF 800	83810

MINI DIN - 3RCA CABLE



TYPE OF CONNECTOR	MODEL	REF.
MINI DIN 5 / 3 RCA	CDM 3 RCA	84033

ACCESSORIES FOR WALL MOUNTING

VENTILATED HOUSING

Designed for wall mounting. Includes all necessary accessories. Ventilation unit and 3 power socket. With safety lock.
Dimensions: 515 x 250 x 370 mm.
Weight: 6,9 Kg.

APPLICATION	MOD.	REF.
7 modules + power supply	CFR 807	83806



FRAME

Designed for installation and protection of the 8000 series headend. Includes all necessary accessories for wall mounting.
Dimensions: 450 x 15 x 170 mm.
Depth with modules: 200 mm.

APPLICATION	MOD.	REF.
7 modules + power supply	BST 807	83805

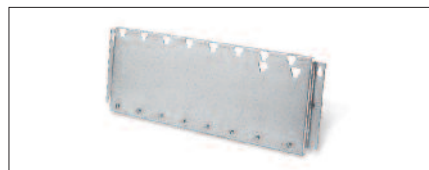

19" RACK VENTILATION UNIT

Designed for installation on BST 807 frame.
Dimensions: 160 x 135 x 50 mm.
Supply voltage: 230 V / 200 mA.
Weight: 0,8 Kg.

APPLICATION	MOD.	REF.
Frame without housing	VNT 800	83818



ACCESSORIES FOR RACK 19" MOUNTING

19" RACK FRAME

Designed for mounting the 8000 series modules on 19" rack.
Dimensions: 485 x 185 x 265 mm.

APPLICATION	MOD.	REF.
7 modules + power supply	BSR 807	83800



VENTILATION UNIT

Designed for installation on 19" rack.
Dimensions: 485 x 285 x 45 mm.
Supply voltage: 230V / 200 mA.

APPLICATION	MOD.	REF.
19" rack	VNT 807	83801

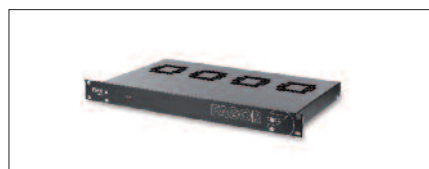

19" RACK ADJUSTMENT PLATES ON

CAM 08: for module.
CAF 08: for power supply.

APPLICATION	MOD.	REF.
19" rack	CAM 08	83802
	CAF 08	83804

CAM 08



CAF 08



APPLICATION EXAMPLES

Example

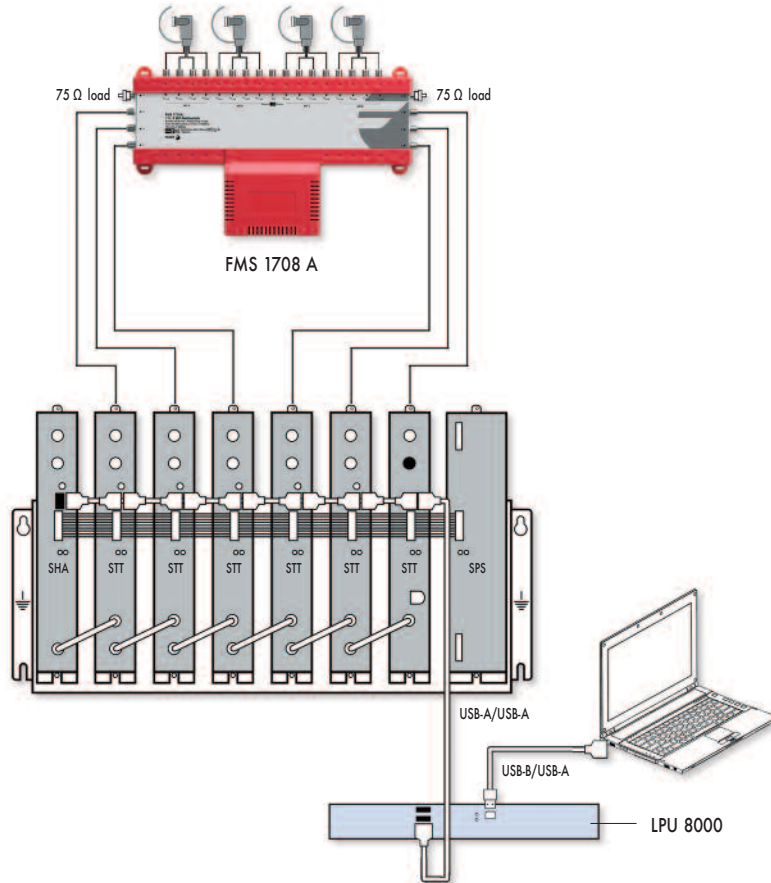

Example

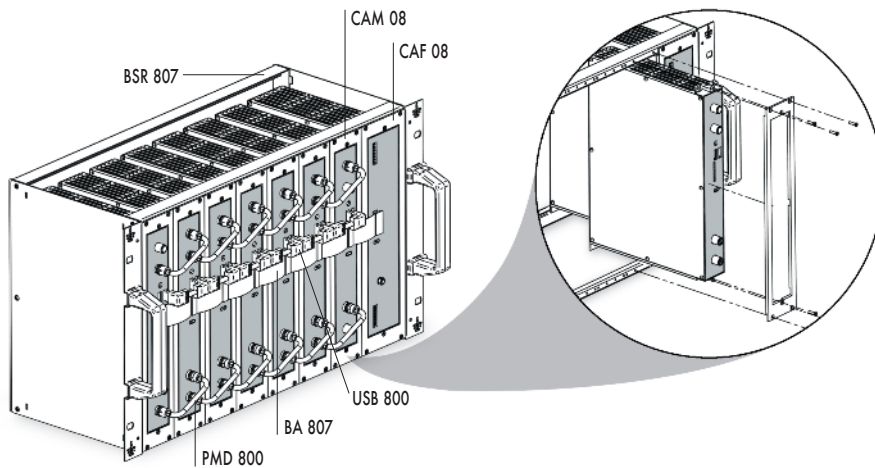

APPLICATION EXAMPLES

Example

HEADENDS

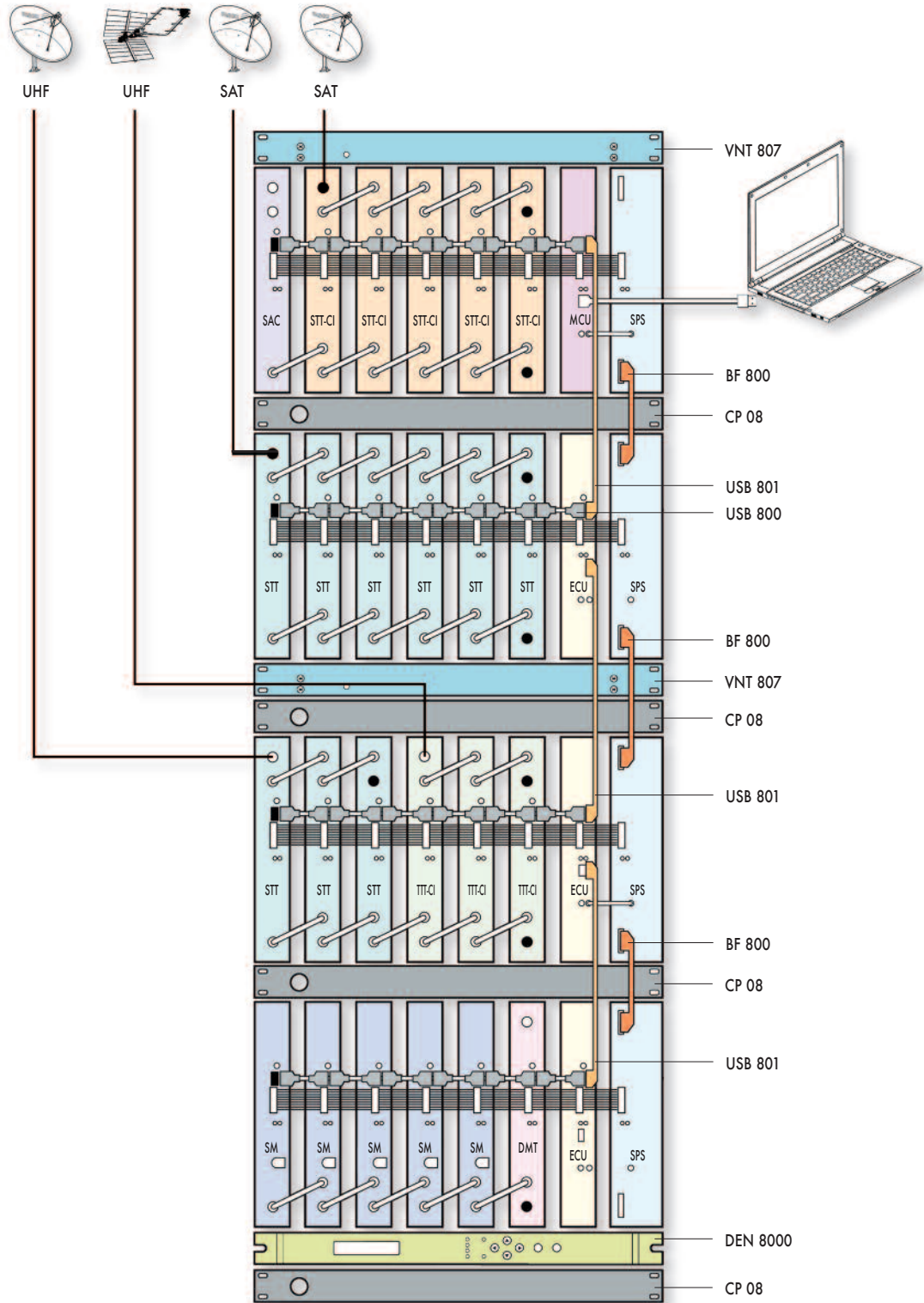

SM 6000+ / SM 7000+ SM 6000+ ST / SM 7000+ ST (STEREO)

Modulator with VSB output, that allows adjacent channel operation. A programmable output channel means that the modulator can easily be inserted into the headend since it operates in any TV channel (BI, BIII, "S" Bands and UHF). The stereo model includes STERO/DUAL signals processing.

APPLICATION

Analogue satellite TV community installations, where locally produced channels insertion is needed.

CHARACTERISTICS

- It allows audio volume adjustment to equalise them to the level of other installed programs.
- It also offers the possibility of fine tuning the output channel frequency to disperse intermodulation products in installations with many channels.
- RF output signal ON/OFF switchable for analysis and headend adjustment.
- Brightness adjustment available.
- Video modulation depth adjustable from 75 to 90%.
- Incorporates test bars generator.
- Output frequency shift.
- Screws and power supply cable included.



Supply voltage	Vdc	30	24	12	5
Current drawn (6,2 W)	mA	1	70	320	133
Operating temperature range					0 ÷ 50° C

MODEL *	SM 6000+	SM 7000+	SM 6000+ST	SM 7000+ST
Reference	19650	19750	19665	19765
Assembly system	Frame	19" Rack	Frame	19" Rack
Input/output connector	F(f)			
Audio/Video input connector	MINI DIN 5 ways (f)			
Audio pre-emphasis	µs	50		
Video input level	Vpp	0,9 ÷ 1,25 / 75Ω		0,8 ÷ 1,1 / 75Ω
Audio input level	Vpp	0,5 ÷ 2,5 (Δ = 13 KHz) / 10KΩ @ 1KHz		
VSB output channel	MHz	E2... 69 (programmable)		
Output level	dBµV	75 ÷ 90 (adjustable)		
Spurious in channel	dBc	- 60		
Spurious in band	dBc	> 54	- 54	
C/N ratio (8 modules)	dB	56		
Carrier accuracy	KHz	± 30		
Carrier stability	KHz	± 10		
Output fine tuning	MHz	± 4,5 (Δ = 125 KHz)		
Video modulation depth (switchable)	%	85 + 5, -10 (Δ = 5%)		
Pv / Ps ratio adjustable	dB	13 + 1, -2 (Δ = 1 dB)		
TV standard		B / G		
Audio output modes		STEREO / DUAL switchable (A/B - B/A)		
Packing dimensions	mm	272 x 166 x 45		
Weight	Kg	1,5		

* Standards available: B/G, I, L, D/K, M, N...

CIF 6000+ A/D / CIF 7000+ A/D

Channel to channel Converter with processing via IF. Allows to change frequencies, without modifying the content of the base band signal. Any channel can be programmed at the output with the UCF 100 External Control Unit. Adjacent input and output channel operation.

APPLICATION

Analog Terrestrial TV installations. COFDM Digital Terrestrial TV community installations.

CHARACTERISTICS

- The built-in AGC circuit keeps a stable output level.
- Enables the conversion of any input channel, in any output channel, eliminating the incompatibilities between channels.
- It allows output signal total disconnection.
- Incorporates a LED with input level information.
- It also offers the possibility of fine tuning the output channel frequency to disperse intermodulation products in installations with many channels.
- Screws and power supply cable included.



Supply voltage	Vdc	30	12	5
Current drawn (7,3 W)	mA	12	450	300
Operating temperature range				0 ÷ 50° C

MODEL	CIF 6000+ A/D	CIF 7000+ A/D
Reference	06426	07426
Assembly system	Frame	19" Rack
Input/output connectors	F (f)	
Input frequency	MHz 47 ÷ 862	
Input fine tuning	MHz ± 4,5 (∅= 125 KHz Analog; 166 KHz Digital)	
Input level	dBμV 65 ÷ 90 Analog; 55 ÷ 80 Digital	
AGC	dB >30	
C / N for 8 modules	56 (input >75 dBμV Analog)	46 (input >65 dBμV Digital)
Output level adjustable	dBμV 75 ÷ 90 Analog; 65 ÷ 80 Digital	
VSB output frequency	E02... 69 (B/G)	
Phase noise	83 dBc / Hz @ 10 KHz 102 dBc / Hz @ 100 KHz	
Output fine tuning	KHz ± 4,5 (Δ = 125 KHz Analog; 166 KHz Digital)	
Spurious in band	dBc - 54	
Carrier accuracy	KHz ± 30	
Carrier stability	KHz ± 20	
Output level stability	dB ± 2	
Channel flatness	dB ± 1	
Image frequency rejection	dB 60	
Input channel rejection at output	dB 60	
Through losses at input	dB ± 1	
Through losses at output	dB 1,5 (47 ÷ 862 MHz)	
Adjacent channel rejection	dB >55	
Packing dimensions	mm 272 x 166 x 45	
Weight	Kg 1,7	

SDM 6000+ / SDM 7000+ SDM 6000+ ST / SDM 7000+ ST (STEREO)

Transmodulator that converts the QPSK modulated signal coming from the satellite into AM channels with analogue modulation for its distribution together with the rest of terrestrial and analogue satellite channels through just one cable. Operates in any TV channel in VSB, allowing adjacent channels operation. The stereo model includes two audio carriers for STERO/DUAL signals processing.

APPLICATION

Community installations where it is necessary to distribute the Digital Satellite TV signal, converted into analogue channels. No need of individual receivers with each TV set.

CHARACTERISTICS

- No need of input splitters or output combiners.
- Displays the S/N ratio to know picture quality.
- Easy programming of the output channel by UCF 100 Control Unit.
- OSD to simplify system parameters programming.
- Baud Rate from 4 to 45 Mbaud.
- Automatic Code Rate detection.
- Menu guided programming with OSD, On Screen Display.
- Teletext and Radio programs identification.
- Screws and power supply cable included.



Supply voltage	Vdc	30	17	12	5
Current drawn (10,5 W)	mA	2	16	430	1000
Operating temperature range					0 ÷ 40° C

MODEL	SDM 6000+	SDM 7000+	SDM 6000+ST	SDM 7000+ST
Reference	27580	27880	27595	27895
Assembly system	Frame	19" Rack	Frame	19" Rack
Output / input connectors	F (f)			
Input frequency	MHz 950 ÷ 2150			
Input modulation type	QPSK (DVB-S compliance)			
Input level	dBµV 49 ÷ 89 (-60 ÷ -20 dBm)			
1 st IF input through losses	dB 1,5			
Dynamic threshold C / N (QEF FEC 3/4)	dBc 8			
1 st IF bandwidth	MHz 55			
AFT pulling range	MHz ± 5			
Baud rate	Mbaud 1,5 ÷ 45 (1 Kbaud resolution)			
FEC	DVB compliance 1/2, 2/3, 3/4, 5/6, 7/8 (automatic)			
Output modulation type	PAL, B/G			
VSB output frequency range	MHz E 2 ÷ E 69 (47 ÷ 862 MHz) programmable			
Output fine tuning	MHz ± 4,5 (Δ = 125 KHz)			
Output through losses	dB 1,5			
Output level	dBµV 75 ÷ 90 (-34 ÷ -19 dBm)			
Spurious in channel	dBc - 60			
Spurious in band	dBc - 54			
Carrier accuracy	KHz ± 30			
Carrier stability	KHz ± 10			
Video modulation depth	% 85			
C/N ratio (8 modules)	dB 56			
Audio output modes	Stereo / Dual switchable (A/B - B/A)			
Packing dimensions	mm 272 x 166 x 45			
Weight	Kg 1,8			

* Standards available: B/G, I, L, D/K M, N...

TDM 6000 / TDM 7000 TDM 6000 ST / TDM 7000 ST (STEREO)

The TDM 6000 / TDM 7000 transmodulator converts a TV or radio channel with COFDM modulation on a terrestrial digital television multiplex into a VHF/UHF channel with standard PAL modulation (MPEG 2). The stereo model includes two audio carriers for STEREO/DUAL signals processing.

APPLICATION

Community installations requiring the distribution of the digital terrestrial TV signal converted into analogue channels. The installation of individual receivers with each TV set is not necessary.

CHARACTERISTICS

- Adjacent channel operation.
- Operates on any VSB output and input channel.
- Automatic detection/configuration of FFT mode (2K, 8K), constellation, Code Rate, guard interval and bandwidth.
- Does not require input splitters or output combiners.
- Makes it possible to know image quality by measuring the BER before Viterbi and by S/N estimation.
- The output channel is easily programmed through the UCF 100 control unit.
- Has an OSD menu to simplify the programming of the system parameters.
- Identification of programs containing teletext and radio.
- Screws and power supply cable included.



Supply voltage	Vdc	30	24	17	12	5
Current drawn (10 W)	mA	1	—	—	430	960
Operating temperature range						0 a 40 °C

MODEL	TDM 6000	TDM 7000	TDM 6000 ST	TDM 7000 ST
Reference	27460	27560	27475	27575
Assembly system	Frame	19" Rack	Frame	19" Rack
Input / Output connectors	F (f)			
Input demultiplexing through losses	dB			
Input frequency	MHz			
Input modulation type	COFDM (DVB-T compliance)			
Channel bandwidth	MHz			
Input level for modulation: 64 QAM, Tu: 1/4 & CR: 2/3	dBµV			
Input impedance	Ω			
COFDM modulation modes	QPSK, 16QAM, 64QAM			
Guard interval (auto-detection)	1/32, 1/16, 1/8, 1/4 of the symbol duration			
FEC	1/2, 2/3, 3/4, 5/6, 7/8			
Frequency resolution	KHz			
Capture range	MHz			
Input signal	Compatible with IEC-ISO 13818-1			
PID filtering	Up to 32 PID			
Video decoding	IEC-ISO 13818-2 compliance			
Aspect ratio	4:3, 16:9			
Video encoding	PAL			
Video output	Video composed on 75 Ω			
Audio output level	1 Vpp over 600 Ω			
Audio output	Stereo, Joint stereo, dual or mono			
Teletext	Inserted in the video output VBI			
Output fine tuning	MHz			
Output frequency range	CCIR B/G			
Output level	dBµV			
Output multiplexing through losses	dB			
Packaging dimensions	mm			
Weight	Kg			

AFM 6000 / AFM 7000

FM amplifier that allows radio signal processing in community headends. Amplifies the whole FM radio band.

APPLICATION

Community installations where FM radio signal distribution is needed.

CHARACTERISTICS

- A built-in FM/RF combiner allows trouble free insertion in any headend.
- Allows selective attenuation of the FM signals by means of its 3 selective Notch Filters.
- Screws and power supply cable included.



Supply voltage	Vdc	34	24
Current drawn (2,1 W)	mA	10	70
Operating temperature range		0 ÷ 50° C	

MODEL		AFM 6000	AFM 7000
Reference		35004	35005
Assembly system		Frame	19" Rack
Input/output connectors		F (f)	
FM frequency range	MHz	87,5 ÷ 108	
TV frequency range	MHz	47 ÷ 75 / 120 ÷ 862	
FM max. output level DIN 45004 B (-35 dB)	dBμV	125	
Return losses	dB	>9	
FM gain	dB	40	
FM gain regulation	dB	20	
Selective attenuation (notch filters)	dB	10 (1 filter) 15 (2 filters) 19 (3 filters)	
TV through losses (47 ÷ 862 MHz)	dB	< 0,5	
FM noise figure	dB	6	
Shielding factor	dB	< 65	
Impedance	Ω	75	
Packing dimensions	mm	272 x 166 x 45	
Weight	Kg	1,2	

SHA 6115 N / SHA 7115 N SAC 6415 N / SAC 7415 N

Broadband Amplifiers for SMATV and CATV headends. The SHA model is a single input amplifier. The SAC Amplifier is a 4 input model to combine and amplify up to 4 frames (32 channels).

APPLICATION

TV community installations, both SMATV and CATV.

CHARACTERISTICS

- They have gain regulation and a TEST point for the output signal level.
- Each input has an amplification step before gain regulation. This way, the noise figure is not directly affected by the gain regulation.
- Screws and power supply cable included.
- Optimum frequency response.
- High dynamic threshold.



		SHA N	SAC N
Supply voltage	Vdc	24	
Current drawn	mA	170 (4 W)	320 (7,7 W)
Operating temperature range		0 ÷ 50° C	

MODEL	SHA 6115 N	SHA 7115 N	SAC 6415 N	SAC 7415 N
Reference	35016	35017	35018	35019
Assembly system	Frame	19" Rack	Frame	19" Rack
Input/output connectors	F (f)			
Number of inputs	1			4
Frequency range	MHz 47 ÷ 862			
Input and output impedance	Ω 75			
Gain	33			37
Gain regulation	dB 20			
Band flatness	4			5
Noise figure @ Max. Gain	5			12
IM3 output level	dBμV 120 (-60 dBc DIN 45004 B)			
CTB output level	dBμV 108 (-60 dBc 42 Ch, EN 50083-3)			
Isolation between inputs				20
TEST output level	dB - 30			
TEST output connector	F (f)			
Packing dimensions	mm 272 x 166 x 45			
Weight	Kg 1,2			

IFL 6000 / IFL 7000

Twin Converter which converts 1st IF SAT signal to be distributed through just one cable. Each IFL unit has a twin conversion module to independently process 2 transponders. Designed for processing Analogue and Digital TV. Can be operated with adjacent transponders, both at input and output.

APPLICATION

Satellite analogue or digital TV community installations in large and medium sized communities, where the 1st IF SAT signal must be distributed through just one cable.

CHARACTERISTICS

- One model is all that is needed for any input and output channel.
- Input and output frequency accuracy are controlled by high precision PLL's, that guarantee a very low phase noise.
- A built-in AGC control fixes the output level.
- IFL-T model is a 1st IF SAT TERMINAL converter and it has 2 independent inputs for processing signals coming from different sources.
- Screws and power supply cable included.



Supply voltage	Vdc	30	17	12	5
Current drawn (4,7 W)	mA	6	20	130	515
Operating temperature range					0 ÷ 50° C

MODEL	IFL 6000	IFL 7000	IFL 6000-T	IFL 7000-T
Reference	06900	07900	06902	07902
Assembly system	Frame	19" Rack	Frame	19" Rack
Number of inputs	1		2 (independent)	
Module capacity	2 Transponders			
Input/output connectors	F (f)			
1 st IF SAT input frequency	MHz 950 ÷ 2150			
Input level	dBµV 49 ÷ 87 (-60 ÷ -22 dBm)			
1 st IF SAT through losses	dB < 1,5			
Return losses	dB > 8			
DC pass for LNB	mA 500 max.			
2 nd IF Bandwidth	MHz 27 / 36 (Switchable)*			
Phase noise (F. in 970 MHz, F. out 2150 MHz)	dBc / Hz -75 @ 10 KHz			
Output frequency	950 ÷ 2150	Channelized mode: steps of 40 MHz Manual mode: steps of 2 MHz		
Output level	dBµV > 78 (-27 dBm)			
Output level regulation	dB 20			
Output frequency stability	MHz ± 0,15			
Level stability (25° C ± 20° C)	dB ± 2			
CAG	dB >40			
Selectivity	Suitable for 40 MHz or 30 MHz channelization			
Packing dimensions	mm 272 x 166 x 45			
Weight	Kg 1,6			

* 54 MHz Bandwidth version available.

IFA 6000 S / IFA 7000 S

Headend amplifier that amplifies the 1st IF SAT signal and combines it with RF channels.

APPLICATION

Satellite TV community installations where IF processors are incorporated.

CHARACTERISTICS

- Includes a RF / 1st IF diplexer which guarantees noise-free terrestrial TV reception.
- Provides an equalized output level to compensate losses in the distribution network.
- Compatible with any existing terrestrial headend.
- Designed for processing Analogue and Digital TV .
- Screws and power supply cable included.



Supply voltage	12 Vdc
Current drawn (3,6 W)	300 mA
Operating temperature range	0 ÷ 50° C

MODEL	IFA 6000 S	IFA 7000 S
Reference	35914	35915
Assembly system	Frame	19" Rack
Input/output connectors	F (f)	
Number of inputs	2 inputs 1 st IF SAT + 1 inputs RF (15 ÷ 862 MHz)	
LNB DC pass voltage (1 st IF input)	mA	17 V (400 max.)
1 st IF SAT input frequency range	MHz	950 ÷ 2300
RF frequency range	MHz	15 ÷ 862
RF insertion losses	dB	< 2
Output band (1 st IF SAT + RF)	MHz	15 ÷ 2300
1 st IF SAT min. input level	dB μ V	59
1 st IF SAT gain (\pm 2dB)	dB	30 (950 MHz) 38 (2150 MHz) 39 (2300 MHz)
RF signal rejection (1 st IF SAT input)	dB	40 (5 ÷ 862 MHz)
Output level DIN 45004B (IM3 - 35 dB)	dB μ V	125 (2150 MHz)
Output level regulation	dB	20
Packing dimensions	mm	272 x 166 x 45
Weight	Kg	1,2

SPS 6000 N / SPS 7000 N SPS 6100+ / SPS 7100+

Power Supply that provides the operating voltage for all modules of the Multi-Processing system.

APPLICATION

Multi-Processing system headends.

CHARACTERISTICS

- Switching mode design to achieve a high performance with maximum efficiency.
- Complies with the UNE-EN 60065 standard as a class I equipment.
- Protected against overloading.
- Screws and power supply cable included.



		SPS N	SPS +
Supply voltage	Vac	187 ÷ 264	
Current drawn	mA	90 W	122 W
Operating temperature range		0 ÷ 50° C	

MODEL	SPS 6000-N			SPS 7000-N			SPS 6100+			SPS 7100+		
Reference	66002			67002			66003			67003		
Assembly system	Frame			19" Rack			Frame			19" Rack		
Output voltage ± 5%	Vdc	30	24	17(LNB)	12	5	30	24	17	12	5	
Output current 65,5 W*	A	0,04	0,3	0,6	2,6	3,2	—	—	—	—	—	
Output current 90 W*	A	—	—	—	—	—	0,016	0,4	0,3	2,9	7,9	
Max. absolute current per output**	A	0,2	2,5	3,4	4	4,5	0,15	1,3	0,4	3,8	9,6	
Max. total output power	W	≤ 67						106				
Packing dimensions	mm	295 x 166 x 67										
Weight	Kg	1,45						1,55				

* Example for 5 SRM + 1 SHA + 2 LNB

* Example for 8 SDM + ST,1 SHA, 1 LNB, in SPS + models

** If total power does not exceed 67 W, in SPS-N models

** If total power does not exceed 106 W, in SPS + models

ACCESSORIES

FRAME

Designed for mounting modules of the SCM 6000 system. The kit supplied includes all necessary accessories for wall mounting.
Dimensions: 488 x 275 x 20 mm
Depth with modules: 200 mm

APPLICATION	MODEL	REF.
9 mod. + power supply	BST 608	83600

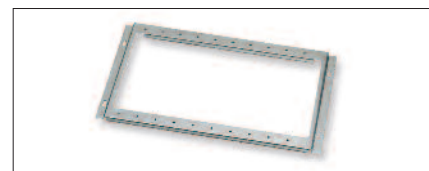

HOUSING

Designed for installation and protection of SCM 6000 system. Includes all necessary accessories for wall mounting. With safety lock.
Allows KIT VNT 56 (Ref. 83004) to be mounted.
Dimensions: 650 x 410 x 205 mm.
Weight 8 Kg.

APPLICATION	MODEL	REF.
9 mod. + power supply	CFR N56 V	83605



VENTILATION KIT

Suitable for assembling on the CFR N56 V housing.

APPLICATION	MODEL	REF.
Housing Ref. 83605	VNT 56	83004

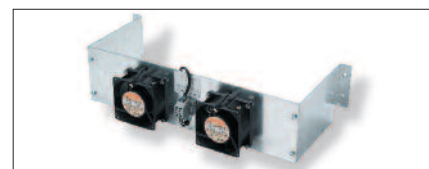

19" RACK FRAME

Designed for installation of SCM 7000 system.
Rack or wall mounting.
Size: 6U height.
Dimensions: 483 x 189 x 265 mm.

APPLICATION	MODEL	REF.
9 mod. + power supply	BST 708	83704



COVERS

CC 01: BLIND COVER
Suitable for covering free slots in the 19" Rack frame.

CP 01: CABLE PASSAGE COVER
Blind cover prepared for cable passage.

APPLICATION	MODEL	REF.
19" Rack frame	CC 01	83701
	CP 01	83702

CC 01



CP 01



VENTILATION UNIT-SCM 7000

Suitable for assembling on the Ref.83704 frame.
• Supply voltage: 220 Vac.
• Power consumption: 22 Watts.
• Size: 1U height

APPLICATION	MODEL	REF.
Frame Ref. 83704	VNT 19	83705

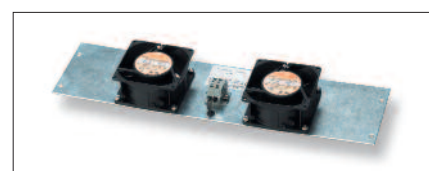

MINI DIN CONNECTOR

Mini DIN connector with 5 male plugs for interconnecting Video/Audio signals between modulator and decoder.

TYPE OF CONNECTOR	MODEL	REF.
MINI DIN 5	MDIN 5	84004



ACCESSORIES

75 Ω F LOAD

Coaxial resistive load for loading open connectors.

TYPE OF CONNECTOR	MODEL	REF.
F (m)	CX 75 F	84011

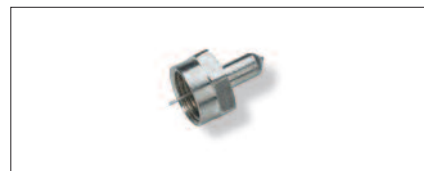

MINI DIN CABLE - EUROCONNECTOR

Mini DIN 5 cable - euroconnector for connecting Video/Audio Stereo signals between modulator and decoder.

Length: 2 m.

TYPE OF CONNECTOR	MODEL	REF.
MINI DIN 5 / Euroconnector	CMD EU-ST	84032



75 Ω F-F COAXIAL BRIDGE

Rigid 75 Ω coaxial bridge for splitting or combining RF signals.

Weight: 47,7 mm.

TYPE OF CONNECTOR	MODEL	REF.
F (m) - F (m)	PMD FF	84031



CONTROL UNIT

Universal control unit designed for programming FAGOR modules.

Packing dimensions: 155 x 110 x 50 mm.

Weight: 0,1 Kg.

TYPE OF CONNECTOR	MODEL	REF.
MINI DIN 8	UCF 100	85100



MINI DIN - 3RCA CABLE

Mini Din 5 / 3RCA cable for connecting Video and Audio Stereo signals to the modulator.

Length: 2 m.

TYPE OF CONNECTOR	MODEL	REF.
MINI DIN 5 / 3 RCA	CDM 3 RCA	84033



PASS FILTER

470 mhz PASS FILTER.

TYPE OF CONNECTOR	MODEL	REF.
F (m) - F (f)	FPA 470	85042



APPLICATION EXAMPLES

HEADENDS

- 47 ÷ 2150 MHz
- 16 digital satellite TV transponders
- 3 analogue satellite TV programs
- 4 digital terrestrial TV programs
- 2 digital terrestrial TV programs
- 1 surveillance channel
- FM Radio
- 5 digital satellite TV programs

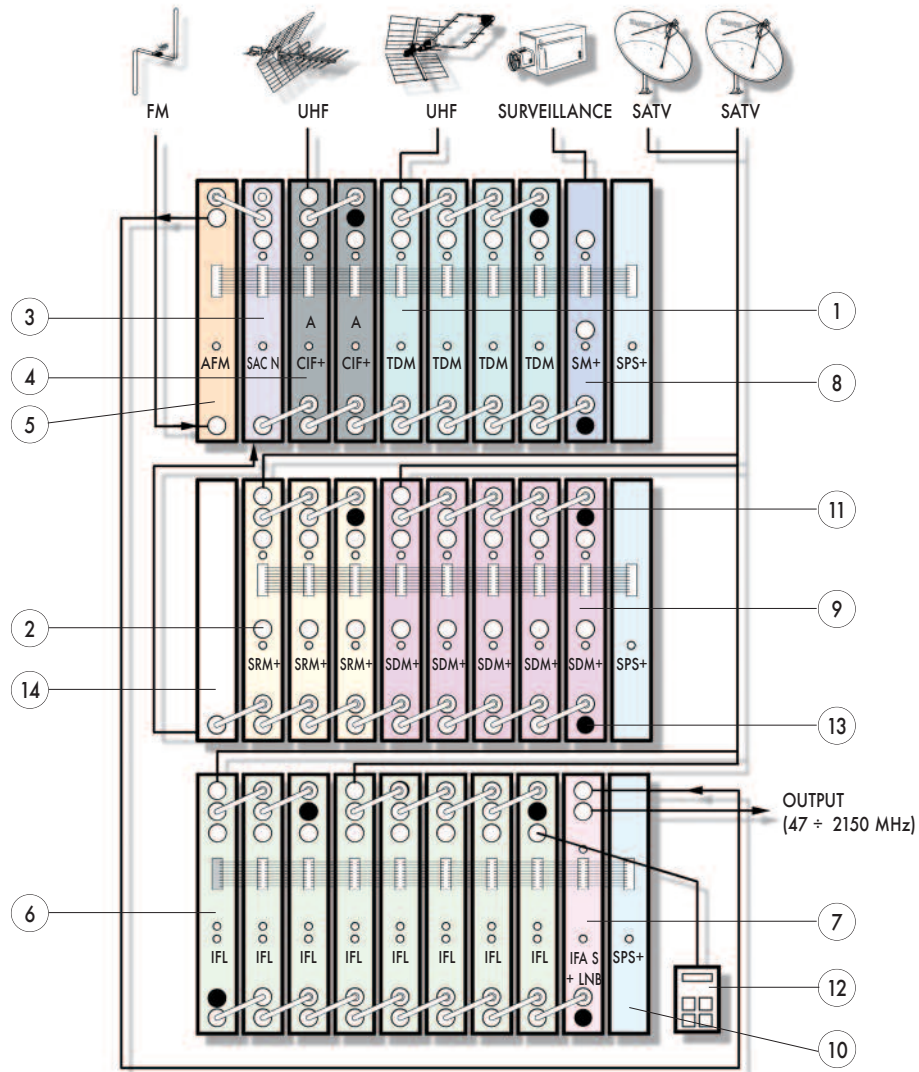

Nr.	DESCRIPTION		SCM 6000	SCM 7000
1	COFDM-PAL Transmodulator	- TDM	Ref. 27460	Ref. 27560
2	Receiver - Modulator	- SRM+	Ref. 27660	Ref. 27760
3	Amplifier - Combiner	- SAC N	Ref. 35018	Ref. 35019
4	Channel Converter via IF	- CIF+	Ref. 06410 - 06424	Ref. 07410 - 07424
5	FM Amplifier	- AFM	Ref. 35004	Ref. 35005
6	1 st IF SAT Twin Converter	- IFL	Ref. 06900	Ref. 07900
7	1 st IF SAT Amplifier	- IFA S	Ref. 35914	Ref. 35915
8	VSB Modulator	- SM+	Ref. 19650	Ref. 19750
9	QPSK - AM Transmodulator	- SDM+	Ref. 27580	Ref. 27880
10	Power Supply	- SPS +	Ref. 66003	Ref. 67003
11	75 Ω F-F coaxial bridge	- PMD FF		Ref. 84031
12	Control unit	- UCF		Ref. 85100
13	75 Ω F load	- CX 75 F		Ref. 84011
14	Cable passage cover	- CP 01	—	Ref. 83702
•	Frame	- BST 608	Ref. 83600	—
•	Housing	- CFR N56V	Ref. 83605	—
•	19" Rack frame	- BST 708	—	Ref. 83704
•	Ventilation kit	- VNT 56	Ref. 83004	—
•	Ventilation unit	- VNT 19	—	Ref. 83705

NEXUM DVB-T/H Series

AGC Channel amplifier suitable for channel amplification of the DTT multiplex in MATV systems. The Nexum DVB-T / H series allows operation in adjacent channel, both in VHF and UHF.

APPLICATION

Medium- to large-sized community digital and analogue TV installations located in poor reception areas with big level differences between channels.

CHARACTERISTICS

- Exceptional selectivity and high output level.
- Constant Output Level within the Input Operative Range, maintaining the quality of the signal.
- High shielding degree, metal chassi (zamak) with "F" connectors.
- Modular design that allows channel configuration according to installation needs.
- Easy to set-up due to its system of splitting at input and combining at output.



1
VERY SIMPLE SET UP

2
NO SERVICE INTERRUPTIONS

3
QUICK INSTALLATION

4
AUTOMATIC ADAPTATION TO WEAK OR STRONG SIGNALS

Supply voltage	24 Vdc
Current drawn	125 mA
Operating temperature range	0 ÷ 50° C

MODEL		NEX 645
Reference		34121...69
Channels		21...69
Max. output level (DIN K)	dBµV	125
Max. COFDM output level	dBµV	118 IMD3 -35 dB
Gain	dB	53
Manual output regulation	dB	20
Operative input range	dBµV	65...95
Min. input level	dBµV	45
Bandwidth	MHz	8
Selectivity	dB	30 fc N ± 8 MHz 60 fc N ± 16 MHz 70 fc N ± 24 MHz
Return losses	dB	9
Noise figure	dB	11
Packing dimensions	mm	195 x 70 x 32
Weight	Kg	0,45

* MER OUT: 30 dB; MER IN 38 dB, OUT Level 75 ÷ 118 dBµV.

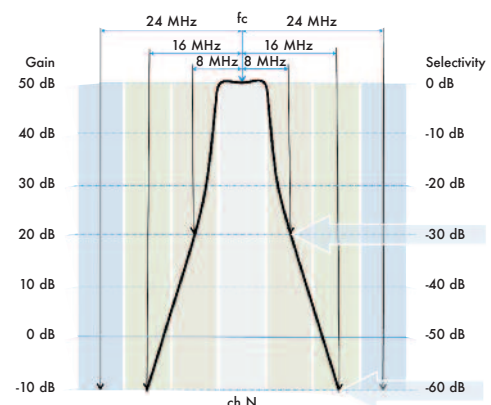
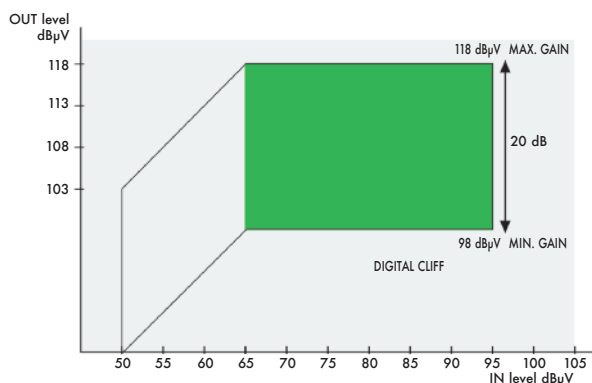

NEX Series

Multichannel amplifier, suitable for amplifying and filtering of TV signals in MATV headend systems. These amplifiers are perfect for working in adjacent channels.

APPLICATION

Medium- to large-sized community digital and analogue TV installations located in poor reception areas with big level differences between channels.

CHARACTERISTICS

- Metal chassis (zamak), integrating the input/output connectors to give the unit great strength.
- High shielding degree.
- High reliability and screening factor due to "F" connectors.
- Modular design that allows channel configuration according to installation needs.
- The use of filters with high "Q" factor (quality factor) inductive lines guarantees a high channel selectivity.
- Easy to set-up due to its system of splitting at input and combining at output.



Supply voltage	24 Vdc
Current drawn (24 Vdc)	110 mA
Operating temperature range	0 ÷ 50° C

MODEL	NEX 401	NEX 402	NEX 403	NEX DAB	NEX 545 2 channels	NEX 545 3 channels	NEX 545 4 channels	NEX 545 5 channels	
Reference	39102...04	39200	39305...12	39201	39501...20	39580...600	39570	39571	
Channels	E02...E04	FM 87 ÷ 108	E05...E12	DAB 195 ÷ 223	— *	— *	66 ÷ 69	65 ÷ 69	
Max. output level	dBµV	123	115 (DIN B -35 dB)	123	115 (DIN B -35 dB)	112 (2 Ch AM-TV) 109 (2 Ch COFDM)	111 (3 Ch AM-TV) 107 (3 Ch COFDM)	109 (4 Ch AM-TV) 106 (4 Ch COFDM)	108 (5 Ch AM-TV) 105 (5 Ch COFDM)
Gain	dB	40	40	35	40	50			
Gain adjustment	dB	30							
Bandwidth	MHz	7	21	7	28	16	24	32	40
Selectivity			@ -15 MHz		@ -15 MHz			N = ch 65	N = ch 64
PV _N -PA _N -1	dB	20	35 23	20	35 23	—	—	16	16
PA _N -PV _N +1	dB	20	@ +15 MHz	20	@ +15 MHz	30	30	—	—
PV+20 MHz	dB	>70	30 8	>70	30 8	30	30	—	—
Return losses	dB	9							
Noise figure	dB	11	4	5	5	11			
Input-Output impedance	Ω	75							
Input-Output connectors		F (f)							
Packing dimensions	mm	195 x 70 x 32							
Weight	Kg	0,45							

* Different configurations upon request.

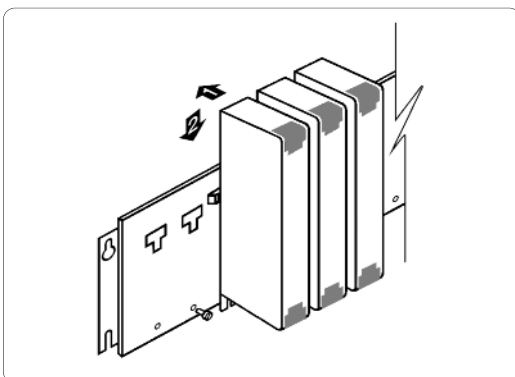

IFA 400

Equalized amplifier for the 950 to 2300 MHz band. Amplifies the 1st IF SAT signal and mixes it with terrestrial channels.

APPLICATION

Community digital and analogue satellite TV installations where the 1st IF SAT signal has to be distributed.

CHARACTERISTICS

- Metal chassis (zamak), integrating the input/output connectors to give the unit great strength.
- High shielding degree.
- High reliability and screening factor due to its "F" connectors.
- Easy to set-up due to its system of splitting at input and combining at output.



Supply voltage	24 (130 mA) Vdc
Current drawn	65 mA
Operating temperature range	0 ÷ 50° C

MODEL		IFA 400
Reference		39204
Frequencies covered	MHz	950 ÷ 2150
Number of inputs 1 st IF		1 (950 ÷ 2150 MHz)
Number of inputs RF		1 (5 ÷ 862 MHz)
Gain (1 st IF)	dB	40 (950 MHz) 48 (2150 MHz)
Noise figure	dB	7
RF signal rejection (1 st IF input)	dB	40 (5 ÷ 862 MHz)
Through losses RF	dB	1,5 (5 ÷ 862 MHz)
Gain adjustment	dB	20 (950 ÷ 2150 MHz)
Output level @2150 MHz	dBμV	125 (DIN 45004B, DIM -35 dBc) 113 (30 transponders, DIM -35 dBc)
Return losses	dB	9
Voltage to LNB		13 Vdc / 300 mA
Packing dimensions	mm	195 x 70 x 32
Weight	Kg	0,35

SPS Series

Power supply module for providing operating voltage to the Nexum series modular system.

APPLICATION

Medium- to large-sized community digital and analogue TV installations located in poor reception areas with big level differences between channels.

CHARACTERISTICS

- Designed using switching techniques, achieves high performance and minimum losses.
- Zamak chassis with metal covers.
- High degree of shielding.
- Protected against overloading.
- Complies with the UNE EN 50083-1; UNE EN 50083-2 standard.



MODEL		SPS 523	SPS 610	SPS 620
Reference		69523	69610	69620
Input voltage	Vac	195 ÷ 265		
Consumption	Watt	65	28,5	30
Output voltage	Vdc	24		12
Max. current output	A	2,3	1	2
Operating temperature range	°C	0 ÷ 50		
Packing dimensions	mm	205 x 70 x 80		
Weight	Kg	0,75		

ACCESSORIES

FRAME

Designed for mounting modules of the Nexum Series Modular System. The kit supplied includes all necessary accessories for wall mounting.

Raster: 40 mm.

Dimensions:

Ref. 83109: 531 x 139 x 15 mm.

Ref. 83110: 747 x 139 x 15 mm.

Ref. 83111: 480 x 177 x 70 mm.

Ref. 83112: 325 x 140 x 15 mm.

APPLICATION	MODEL	REF.
6 mod. + power supply	BST N06	83112
12 mod. + power supply	BST N12	83109
18 mod. + power supply	BST N18	83110
10 mod. + power supply for 19" Rack mounting	BSK N10	83111

BST N12 and BST N18



BSK N10

HOUSING

Designed for installation and protection of Nexum system. Includes all necessary accessories for wall mounting. With safety lock. Allows KIT VNT 56 (Ref. 83004) to be mounted.

Dimensions:

Ref. 83608: 365 x 165 x 250 mm. (2 Kg)

Ref. 83609: 570 x 165 x 250 mm. (4 Kg)

Ref. 83607: 725 x 165 x 250 mm. (6 Kg)

Ref. 83604: 790 x 209 x 595 mm. (8 Kg)

APPLICATION	MODEL	REF.
6 mod. Nexum+power supply	CFR N106	83608
12 mod. Nexum+power supply	CFR N112	83609
18 mod. Nexum+power supply	CFR N118	83607
Housing for 2x18(2x12) Nexum or 1x18 (1x12) Nexum + 1x8 SCM 6000 ventilation unit 83004	CFR N218	83604



CFR N218 / CFR N118

75 Ω F-F COAXIAL BRIDGE

Rigid 75 Ω coaxial bridge for splitting or combining RF signals.

Raster: 40 mm.

TYPE OF CONNECTOR	MODEL	REF.
F (m) - F (m)	PMD FFN	84034



BAND AMPLIFIER

- Frequency band: 470 to 862 MHz
- Gain: 12 dB
- Max. output level: 105 dBuV
- Noise figure: 3,5 dB
- Band flatness: 2 dB
- Power supply: 24V ± 5%
- Consumption: < 50 mA

TYPE OF CONNECTOR	MODEL	REF.
F(f) - F(m)	ABF 012	85053

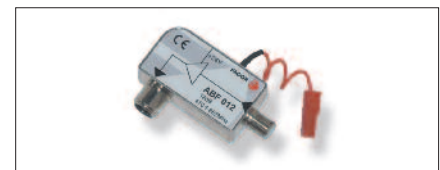

SUPPLY INJECTOR

Frequency band: 5 to 2150 MHz

Return losses: -10 dB

Through losses: 0,5 dB

DC pass: 1A

TYPE OF CONNECTOR	MODEL	REF.
F(f) - F(m)	ICF 001	85051

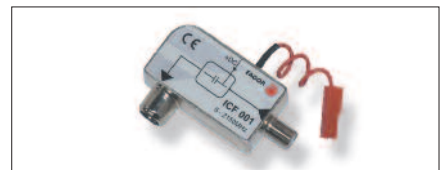

APPLICATION EXAMPLES

- 47 ÷ 2150 MHz
- 2 polarities of 1st IF SAT
- 8 terrestrial channels, analogue or digital
- FM radio
- DAB radio

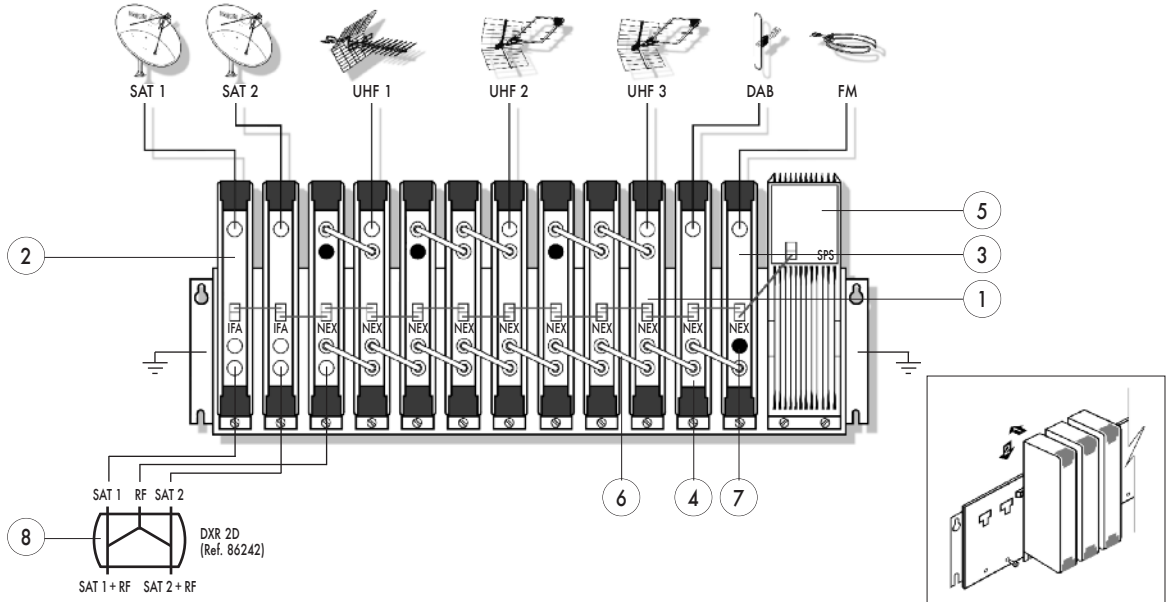

Nr.	DESCRIPTION		Nexum Series
1	Channel amplifier	- NEX 645 DVB-T/H	Ref. 34121...69
2	1 st IF SAT amplifier	- IFA	Ref. 39204
3	Amplifier FM radio	- NEX 402	Ref. 39200
4	Amplifier DAB radio	- NEX DAB	Ref. 39201
5	Power supply	- SPS	Ref. 69023
6	75Ω F-F coaxial bridge	- PMD FFN	Ref. 84034
7	Load	- CX 75F	Ref. 84011
8	Splitter- Combiner	- DRX 2D	Ref. 86242

MicroMATV *Evo* Series

Universal Amplification System for headends with 10 UHF filters, that allows up to 7 configurations with 1, 2 or 3 UHF antennas.

APPLICATION

Designed for large and medium-sized MATV headends.

CHARACTERISTICS

- AES function: patented system which automatically regulates the input signals, guaranteeing a balanced output level.
- AGC function in real time for each input channel.
- Automatic recognition of channel type: digital or analogue.
- Easily programmable with the UCF 200 or UCF 300 control unit, using a simple and intuitive menu. With memory to clone up to 8 different configurations.
- It incorporates amplification of 1st IF SAT. (EVO 200 & 300).
- Auxiliary input for channels processed by other equipment.
- Exceptional screening factor.
- Remote pre-amplifiers powering at U1,U2 and U3.
- TEST output (-30 dB).
- Models with D: LTE optimised.









Consumption	38 W
Supply to LNBS	0V/13V/17V/0Hz/22KHz, 300mA
Mains supply	195 ÷ 265
Working temperature	0-50 °C



INPUTS

Band	FM	BI	BIII/DAB	AUX	UHF1	UHF2	UHF3	(1) 1 st IF SAT	
Bandwidth MHz	87,5÷108	47÷68	174÷230	47÷68 130÷862	470÷862	470÷862	470÷862	950÷2150	
Number of amplifiers	1	1	1	1	10			1	
Filter width	—				Programmable: 1 ÷ 6 channels			—	
Configuration of number of amplifiers per input	No				0	10	0	No	
					0	9	1		
					0	8	2		
					3	5	2		
					3	6	1		
					3	7	0		
Gain (2) dB	40	40	40	23	53	53	43	37÷45 (3)	
Input Regulation dB	25	25	25	No	30			—	
OUT Regulation dB	—	20				20			
AGC (only AGC models)	No				Programmable			No	
Selectivity ± 20 MHz dB	—				25			—	
Noise figure dB	6	6	8	15	6			15	
Operational input level dBµV	analogue	71/101	70/95	70/93	90	60-105		70-100	68/88
	digital	—	55/80	55/78	75	50-95		60-90	
Decoupling between inputs dB	—				20			—	
Remote power (100 mA total)	—				0-24			—	

OUTPUTS

MODEL	 MMTV [®] Evo		 MMTV [®] Evo		 MMTV [®] Evo		 MMTV [®] Evo		 MicroMATV [®] Evo		 MicroMATV [®] Evo			
	100 C	D 100 C	100	D 100	200 C	D 200 C	200	D 200	300 C	D 300 C	300	D 300		
Reference	35581	35541	35571	35531	35582	35542	35572	35532	35583	35543	35573	35533		
Number of outputs	1				1				2					
Band	RF				RF+1 st IF SAT				RF		RF+1 st IF SAT			
Bandwidth MHz	47÷68 130÷862				47÷68 130÷862		950÷2150		47÷68 130÷862		47÷68 130÷862		950÷2150	
Output level IM3 DIN45004B (4) dBµV	123				124		121		120		120		121	
Packing dimensions mm	390 x 275 x 60													
Weight Kg	4,5													

(1).- 1st IF SAT input (only MicroMATV Evo 200 C and MicroMATV Evo 300 C).

(2).- -4 dB lower (MicroMATV Evo 300 C model).

(3).- Fixed 8 dB slope between begin and end of band.

(4).- -60 dBc for TV PAL and -35 dBc for FM, and 1st IF SAT.

UCF 300

Control unit valid for programming a MicroMATV *EVO* by means of a simple and intuitive menu. With memory for cloning up to 8 different configurations and one-key programming of more than one MicroMATV *EVO*. Includes protector sleeve.



MODEL		UCF 300
Reference		85115
Display		Alphanumerical, (2 x 16 characters)
Packing dimensions	mm	46 x 18 x 14
Weight	Kg	0,2

USB BUS ADAPTER

BUS ADAPTER 1.7

Communication interface between computer and UCF 300 control unit for:

- Automatic programming of the MicroMATV *EVO* by means of the "Programmation Guide".
- Recording of configurations/installations in the computer.
- Export of configurations to the UCF 300 control unit for future installations.

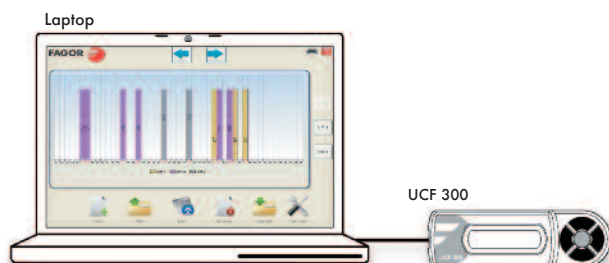

MODEL		BUS ADAPTER 1.7
Reference		85103
Packing dimensions	mm	165 x 65 x 50
Weight	Kg	0,2

MicroMATV Book

Programmable selective amplifier for receiving analogue and digital signals in single-family homes and small communities. All programming can be carried out quickly and easily by means of the keypad and display on the unit itself.

APPLICATION

Suitable for small- and medium-sized installations. Ideal for use in low cost community projects.

CHARACTERISTICS

- 2 programmable UHF inputs distributed between 5 programmable filters with width of up to 7 channels per filter, giving a total capacity of 7x5=35 channels.
- 1 BI/BIII/DAB input.
- 1 FM input.
- 1 auxiliary input.
- Output level directly programmable from keypad.
- 4-digit display and 5-key keypad incorporated.
- UHF and VHF filter extension module.
- 3 additional filters with Book Extend.
- MicroMATV Book D (Ref. 35559): LTE optimised.



MODEL	MicroMATV Book				
Reference	35556				
Band	BI/BIII/DAB	UHF		AUXILIAR	FM
N° inputs	1	2		1	1
N° filters	Broadband	5 programable		Broadband	Broadband
Input and filter configuration	—	UHF 1 5 4 3	UHF 2 0 1 2	—	—
Bandwidth	MHz 47 ÷ 68 174 ÷ 230	470 ÷ 862		47 ÷ 862 132 ÷ 862	87,5 ÷ 108
Programmable filter width (channels)	—	1 ÷ 7		—	—
Gain	dB 35	45 (35)		18	30
Independent regulation per filter	dB 30	30		—	30
Selectivity N (+20 MHz)	dB —	20		—	—
Noise figure	dB 8	9		—	6
Operational input level	dBµV - Analogue - Digital	70 ÷ 93		60 ÷ 83 / (70 ÷ 93)	90
		60 ÷ 83		50 ÷ 73 / (60 ÷ 83)	80
Output level DIN 45004B -60 dBc	dBµV	114			105
Operational output level for 10 analogue channels	dBµV	107			—
Operational output level for 10 digital channels	dBµV	97			—
Programmable DC pass 0 / 12 / 24 VDC	mA	—	50	50	—
Supply voltage	V	230 ± 15%			
Current drawn máx.	W	17			
Operating temperature	°C	0 ÷ 50			
Dimensions	mm	280 x 220 x 63			
Weight	Kg	1,35			

3 ADDITIONAL FILTERS

MODEL	Book Extend 0.3	Book Extend 3.0
Reference	35565	35568
Band	MHz 470 ÷ 862	174 ÷ 240
Number of filters	3	
Dimensions	mm 160 x 140 x 40	
Weight	Kg 0,48	

Book Extend



MicroMATV Book 5+3

This module adds three filters to MicroMATV Book 5+3 allows to configure an 8 filters programmable headend. UHF filters are configurable in width between 1 and 7 channels.

APPLICATION

Suitable for small-and medium-sized installations. Ideal for use in low cost community projects.

CHARACTERISTICS

- 8 programmable filters with a programmable width of 7 channels per filter.
- Auxiliary input for channels processed by other equipment.



HEADENDS

MODEL	MicroMATV Book 5+3					
Reference	35558					
Bands	FM	BI/BIII/DAB	UHF			AUXILIAR
Nbr. of inputs	1	1	1	2	3	1
Nbr. of filters	Broadband	Broadband	8 program.			Broadband
Input and filter configuration	—	—	UHF 1 5 4 3	UHF 2 0 1 2	U 3 3 3 3	—
Bandwidth MHz	87,5 ÷ 108	47 ÷ 68 132 ÷ 862	470 ÷ 862			47 ÷ 68 132 ÷ 862
Programmable filter width (channels)	—	—	1 ÷ 7			—
Gain dB	30	35	45 (35)			18
Independent regulation per filter	dB	30	30			—
Selectivity N (± 20 MHz)	dB	—	20			—
Noise figure dB	6	8	9			—
Operational input level - Analogue - Digital	dBµV	71 ÷ 101 —	60 ÷ 83 / (70 ÷ 93) 50 ÷ 73 / (60 ÷ 83)			90 80
Output level DIN 45004B -60 dBc	dBµV	105	114			
Operational output level 10 analogue channels	dBµV	—	107			
Operational output level 10 digital channels	dBµV	—	97			
DC pass 0 / 12 / 24 VDC programmable	mA	—	50	50	50	—
Supply voltage	V	230 ± 15%				
Current drawn	W	17				
Operating temperature range	°C	0 ÷ 50				
Dimensions	mm	360 x 220 x 80				
Weight	Kg	1,85				

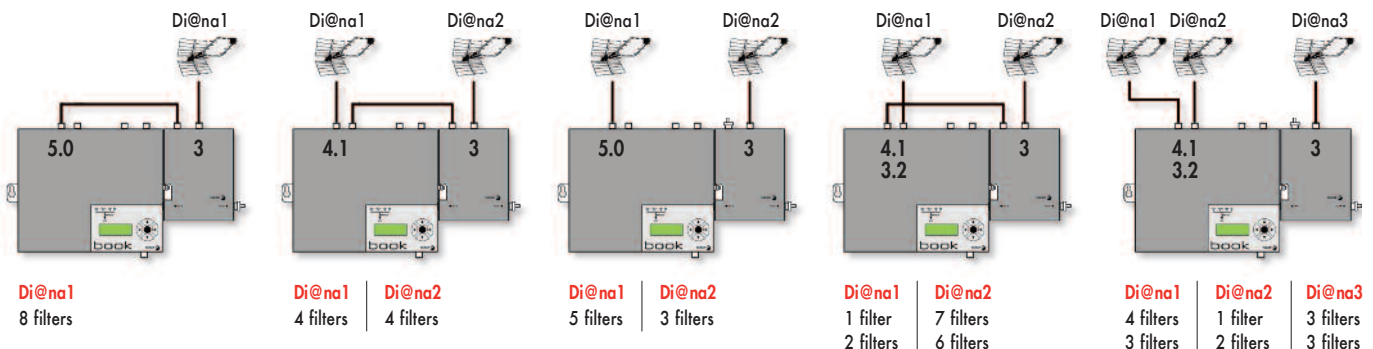

ACCESSORIES

DOUBLE TRAP FILTER

Frequency band: 470 ÷ 862 MHz
 In band return losses
 (out of notch filter): >10 dB
 Rejection at central frequency (Fc): 18 dB at 470 MHz / 10 dB at 862 MHz
 Rejection at $F_c \pm 12$ MHz: 2 dB
 In band through losses: <1 dB
 DC pass: 1 A

TYPE OF CONNECTOR	MODEL	REF.
F(f) - F(m)	FTF 245	85052



BAND AMPLIFIER

Frequency band: 470 ÷ 862 MHz
 Gain: 12 dB
 Flatness: 2 dB
 Noise figure: 3,5 dB
 Power supply: 24 V \pm 5%
 Consumption: <50 mA
 Output level: 105 dB μ V

TYPE OF CONNECTOR	MODEL	REF.
F(f) - F(m)	ABF 012	85053



SUPPLY INJECTOR

Frequency band: 5 ÷ 2150 MHz
 Return losses: -10 dB
 Through losses: 0,5 dB
 DC pass: 1 A

TYPE OF CONNECTOR	MODEL	REF.
F(f) - F(m)	ICF 001	85051

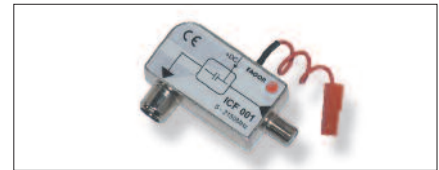

ADJUSTABLE ATTENUATOR

Frequency band: 5 ÷ 2150 MHz
 Return losses: -10 dB
 Through losses: 0,5 to 20 dB
 DC pass (0-22 KHz): 1 A

TYPE OF CONNECTOR	MODEL	REF.
F(f) - F(m)	ATF 020	85050



FIXED ATTENUATOR

Covered band: 5 ÷ 2400 MHz
 Return losses: -10 dBDC Block

TYPE OF CONNECTOR	MODEL	REF.
F(f) - F (m)	FAT 010	85041



APPLICATION EXAMPLES

Book Extend
5+3 filters UHF

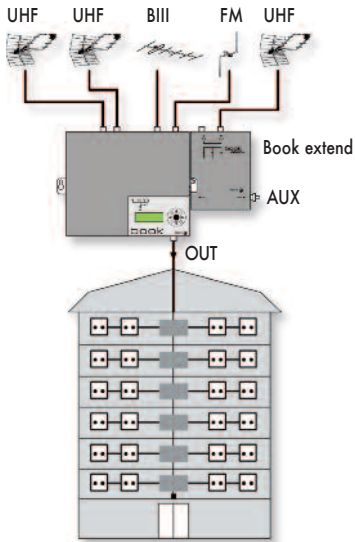

MICROMATV Book
5 filters UHF

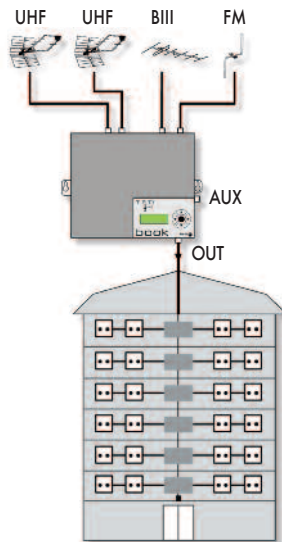

MicroMATV EVO 300
10 filters UHF

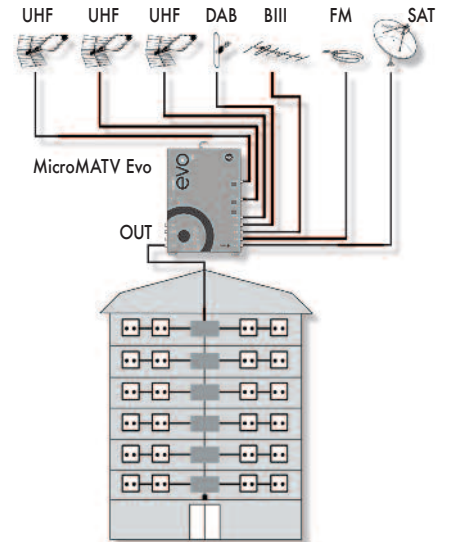

MicroMATV EVO 300 + IFA 3000 book

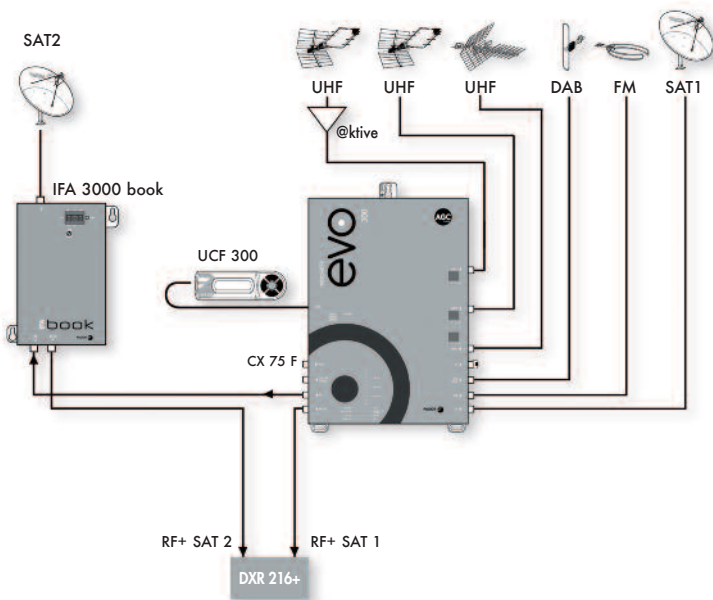

MicroMATV EVO 100

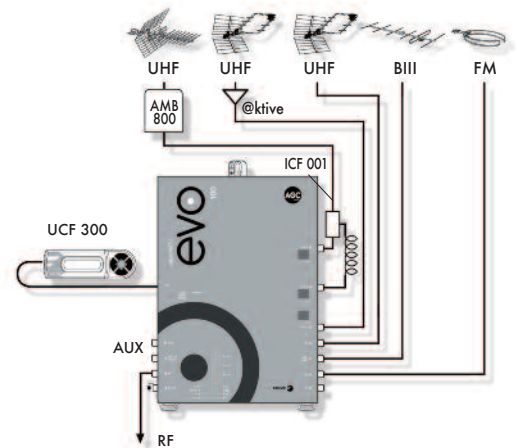

SABAL Series

Amplifiers specially designed for distribution of TV signals up to 862 MHz.

APPLICATION

Designed to work under adverse weather conditions, where a robust amplifier is needed.

CHARACTERISTICS

- Their circuit is integrated in a Zamak box, which ensures correct operation of the amplifier.
- HA 50x models: LTE Ready.
- The amplifier has been optimised by specific circuits which protect it against telecommunications services on adjacent frequency bands.
- Integrates a switch mode power supply to reduce the inside temperature and help extend the life of the equipment.



Supply voltage	230 Vac ± 15 %
Operating temperature range	0 ÷ 50° C

MODEL	HA 405					HA 503			HA 504				HA 505								
Reference	35945					35943			35942				35941								
Inputs	BI	FM	BIII	UHF	UHF	BI/FM	BIII	UHF	BI/FM	BIII	UHF	UHF	BI/FM	BIII	BIV	BV	UHF				
Covered frequencies	47-68	87,5-108	174-230	470-862	470-862	47-108	174-230	470-862 470-790**	47-108	174-300	470-862 470-790**	470-862 470-790**	47-108	174-300	470-862	590-862 590-790**	470-862 470-790**				
Output level*	dBμV					117			125				117								
Gain	40	30	40			38	50	38			50				38						
Gain regulation	dB																				
Test output	dB																				
Noise factor	4,5	5,5	7,5	6,5		5,5	4,5	6,5	5,5	4,5	6,5	5,5	4,5		6,5						
DC pass 12 Vdc	mA					No			100				100								
Weather protection	IP63																				
Power	Vac																				
Power consumption (max)	W					12			16				18				20				
Packing dimensions	mm																				
Weight	Kg																				

* UHF: DIN 45004 B (-60 dB)

** 790/862 MHz selectable by a switch

SAB Series

Band amplification system with separate VHF and UHF signal processing, to reduce the IM2 products.

APPLICATION

Designed as band amplifier for community installation.

CHARACTERISTICS

- The circuit is housed in a single-part metal case which includes all the input-output connectors.
- It has shielding at the top and bottom.
- High level of mechanical rigidity and complete protection against electrical interference.



Supply voltage	230 Vac -10 % +15%
Current drawn	10 VA
Operating temperature range	0 ÷ 50° C

MODEL	SAB 304	SAB 404
Reference	35304	35404
Number of inputs	4	4
Band coverage	BI / FM / BIII / UHF	BI / FM / BIII / UHF
Output level DIN 45004B (-60 dB)	dBµV 109	117
Gain	dB 30	40 / 33 / 40 / 40
Input and output impedance	Ω 75	75
Noise figure	dB 5	5
Regulation	dB 20	20
Auxiliary output + 24v	mA 20	—
Packing dimensions	mm 250 x 125 x 62	
Weight	Kg 0,8	

SAB 304

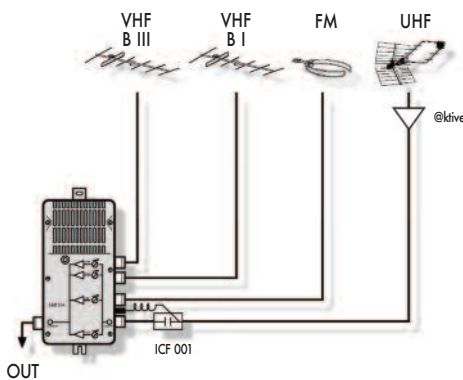

SAB 404

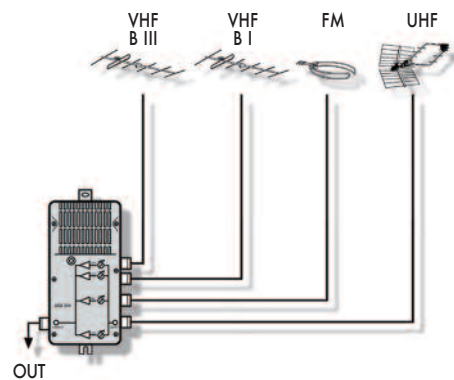

SUMMA Series

Medium-power amplifiers designed for distribution of terrestrial and satellite TV signals.

APPLICATION

Suitable for headend amplification of the signal coming from multiple antennas in community installations.

CHARACTERISTICS

- Supply to pre-amplifiers at UHF inputs: 0/12/24 Vdc, switch selectable.
- Regulation by attenuators for higher linearity (on models with 20dB of regulation).
- Interstage attenuation on all models to ensure optimum noise figure in any situation.
- Adapted to the digital dividend, UHF higher frequency switchable between 790 and 862 MHz. (FMA 338-35955 not LTE switchable).
- SAT input models: Model 538S FMA signal generator available for LNB control: 0/13/18V, 0/22KHz and others allow the passage of the signal from an individual receiver.
- Switching power supply, which reduces consumption and internal temperature, and guarantees a long life of equipment.
- Robust metal box.
- Test output: -30 dB of output level.



Input power supply	230 Vac \pm 15%
Operating temperature	0 \div 50 $^{\circ}$ C
Packing dimensions	257 x 147 x 89 mm
Weight	0,95 Kg

MODEL	FMA 238		FMA 338		FMA 430			
Reference	35954		35955		35950			
Nbr. of inputs	2		2		4			
Band	FM;DAB	UHF	FM;DAB	UHF	BI:FM	BIII;DAB	UHF	SAT
Band coverage	88 \div 108 174 \div 230	470 \div 790/ 470 \div 862**	88 \div 108 174 \div 230	BIV: 470 \div 590/ BV: 614 \div 790	47 \div 108	174 \div 230	470 \div 790/ 470 \div 862**	950 \div 2300
Gain	24	38	24	38	15	20	30	-2
Regulation	20		20		15			
Noise figure	6		6		7		6	—
Output level *	110	116	110	116	106		112	—
Power supply 0/12/24 V	—	80	—	80	—	—	50	—

MODEL	FMA 430 S				FMA 438			
Reference	35951				35953			
Nbr. of inputs	4				4			
Band	BI-FM	BIII;DAB	UHF	SAT	BI-FM	BIII;DAB	UHF	UHF
Band coverage	47 \div 108	174 \div 230	470 \div 790/ 470 \div 862**	950 \div 2300	47 \div 108	174 \div 230	470 \div 790/ 470 \div 862**	470 \div 790/ 470 \div 862**
Gain	15	20	30	20(950 MHz) 25(2150 MHz)	28	30	38	
Regulation	15				20			
Noise figure	7		6	10	7		9	
Output level *	106		112	115	110		116	
Power supply 0/12/24 V	—	—	50	—	—	—	90	

MODEL	FMA 538					FMA 538 S				
Reference	35956					35952				
Nbr. of inputs	5					5				
Band	BI-FM	BIII;DAB	UHF1(21-34)	UHF2(36-69)	UHF	BI-FM	BIII;DAB	UHF	UHF	SAT
Band coverage	47 \div 108	174 \div 230	470 \div 582	582 \div 790/ 582 \div 862**	470 \div 790/ 470 \div 862**	47 \div 108	174 \div 230	470 \div 790/ 470 \div 862**	470 \div 790/ 470 \div 862**	950 \div 2300
Gain	28	30	38			28	30	38		31(950 MHz) 38(2150 MHz)
Regulation	20					20				
Noise figure	7		9			7		9		10
Output level *	106		116			110		116		120
Power supply 0/12/24 V	—	—	90			—	—	90		—

* Terrestrial: DIN 45004 B (-60 dB) SAT: DIN 45004 B (-35 dB).

** UHF frequency between 790 and 862 MHz switchable. (FMA 338-35955 not LTE switchable).

SUMMA BASIC Series

Amplifiers designed for the distribution of TV signals up to 862 MHz or 790 MHz.

APPLICATION

Suitable for headend amplification of the signal coming from multiple antennas in individual or community installations, medium or small sized.

CHARACTERISTIQUES

- Modern design and small size, making it easier to install.
- Amplification and independent regulation per input.
- High performance switching power supply, which provides a high output current with less consumption, and guarantees a long life product.
- Various models with DC pass.
- LED power indicator.



Power supply	230 Vac -15% +10%
Working temperature	0 ÷ 50° C
Packing dimensions	150 x 130 x 50 mm
Weight	0,34 Kg

MODEL	FMB 113	FMB 112C	FMB 132		FMB 233		FMB 233 L		FMB 232		FMB 242 L	
Reference	35303**	35306**	35307**		35308**		35309		35310		35311	
Nbr. of inputs	1				2							
Band	UHF	UHF	Bi;BIII	UHF	Bi;FM;BIII	UHF	FM	BIII;UHF	Bi;BIII	UHF	Bi;BIII;UHF	UHF
Gain	38	28	28	38	28	38	28	28/38	27	27	27	27
Regulation	15	15	25	15	25	15	25	25/15	15	15	15	15
Noise figure	3	4	5	3	5	3	5	5/3	5	3	8	8
DC pass	—	24 Vdc, 40 mA switchable	—		—		—		—		—	
Output level *	dBµV		114		114		114		108	114	110	
Output test	dB		-30		-30		-30		-30		—	

MODEL	FMB 343			FMB 333			FMB 342 C			FMB 342 CB			FMB 342			
Reference	35312**			35313**			35315			35316			35317			
Nbr. of inputs	3															
Band	Bi;FM;BIII	UHF	UHF	Bi;FM	BIII	UHF	FM	BIII-DAB	UHF	Bi;BIII	UHF	UHF	Bi;BIII	UHF	UHF	
Gain	28	38	38	28	28	38	18	18	28	27	27	27	20	27	27	
Regulation	25	15	15	25	25	15	15	15	15	15	15	15	15	15	15	
Noise figure	5	6	6	5	5	3	5	6	4	5	6	6	7	7	7	
DC pass	—			—			—			24Vdc, 40 mA switchable	—	12Vdc, 40 mA	12Vdc, 40 mA	—		
Output level *	dBµV			114			114			114			110			
Output test	dB			-30			-30			-30			—			

MODEL	FMB 442 C				FMB 443 C				FMB 452				
Reference	35318				35319				35320				
Nbr. of inputs	4												
Band	FM	BIII-DAB	UHF1***	UHF2***	FM	BIII-DAB	UHF1***	UHF2***	Bi/BIII	UHF1(21-35)	UHF2(36-69)	UHF	
Gain	15	20	26	26	15	26	36	36	27	27	27	27	
Regulation	20	20	15	15	20	20	15	15	15	15	15	15	
Noise figure	4	4	4	4	4	4	3	3	5	6	7	7	
DC pass	—		24Vdc, 30 mA switchable	24Vdc, 30 mA switchable	—		24Vdc, 30 mA switchable	24Vdc, 30 mA switchable	—				
Output level *	dBµV		106		111		106		111		108		114
Output test	dB												

* DIN 45004B (-60dB)

** Available models adapted to the digital dividend: FMB 112CD, FMB 113D, FMB 132D, FMB 333D, FMB 233D (without FM).

*** Configurable inputs, on request.

IFA 3000 Book

1st IF SAT amplifier with programmable supply voltage for a Universal LNB and diplexed combining of the VHF and UHF channels.

APPLICATION

Community satellite TV installations with IF processors.

CHARACTERISTICS

- A high performance RF / 1st IF SAT diplexer guarantees a noise free terrestrial TV reception.
- It provides optional supply voltage for the LNB, any possibility (0, 13, 17 V // 0, 22 KHz).
- The 1st IF SAT amplification with positive slope (more gain in high frequencies: 8 dB) to compensate the cable attenuation, allows distribution of the 1st IF SAT signal to more users.



Supply voltage	195-265 Vac
Current drawn	12 W
Operating temperature range	0 ÷ 50° C

MODEL	IFA 3000 BOOK	
Reference	35911	
Input/Output connectors	F (f)	
Number of inputs	1 input 1 st IF SAT + 1 input RF	
LNB DC pass	mA	0, 13, 17 V // 0, 22 KHz (250 mA)
1 st IF SAT Frequency range	MHz	950 ÷ 2300
1 st IF SAT input rejection	dB	40 @ 5 ÷ 862 MHz
RF Frequency range	MHz	5 ÷ 862
RF Through losses	dB	1,5
Output band covered	MHz	5 ÷ 2300
IF Input level	dB μ V	68 - 88
1 st IF SAT Gain	dB	35 @ 950 MHz 47 @ 2150 MHz
Gain regulation	dB	20
Noise figure	dB	8
Output level @ 2150 MHz	dB μ V	120 (DIN 45004B, -35 dBc) / 110 (15 transponders)
Packing dimensions	mm	103 x 171 x 23
Weight	Kg	0,75

MicroMATV EVO 300 + IFA 3000 book

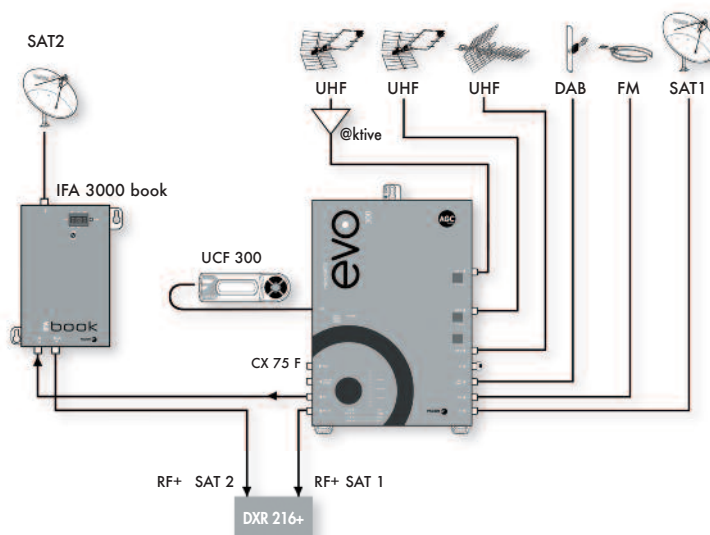

HTT 100 - QUALIO

Digital Modulator to convert a HDMI signal into a DVB-T channel.

APPLICATION

Processes HDMI signals from Satellite Receivers, Computers, Cameras or DVD and Blu-Ray Players into COFDM signals.

CHARACTERISTICS

- Fully configurable bitrates.
- Powerful multiplex configuration.
- RF input/output combiner.
- ASI bus, IPTV (RJ45), RF outputs.
- Interchangeable input modules.
- Logical Channel Numbers.
- Excellent modulation quality MER \geq 42dB.
- LCD display & local configuration.
- Well ventilated, pressed metal chassis.
- Remote configuration via ethernet.
- Backup/Restore saved configurations.
- IPTV unicast/multicast streams.
- VLC compatible IPTV (MPTS) stream.
- Simultaneous IP output.



Power supply	AC 100V~240V
Operating temperature range	0 \pm 45° C

MODEL		HTT 100
Reference		86525
VIDEO ENCODING		H.264/AVC High Profile Level 4.0(HD)
Input		HDMI x 1 + 1 (backup)
Resolution		1920*1080_60P, 1920*1080_50P, (-for MPEG4/H.264) 1920*1080_60i, 1920*1080_50i, 1280*720_60p, 1280*720_50P 720*480_60i, 720*576_50i
AUDIO ENCODING		MPEG1 Layer II
Sample rate	KHz	48
Bit rate	Kbps	64, 96, 128, 192, 256, 320
MODULATION STANDARD		EN300744
FFT mode		2K, 8K
Bandwidth	MHz	6, 7, 8
Constellation		QPSK, 16QAM, 64QAM
Guard interval		1/4, 1/8, 1/16, 1/32
FEC		1/2, 2/3, 3/4, 5/6, 7/8
MER	dB	42
RF frequency		30~960 MHz, 1 KHz step
RF output level		81~97 dB μ V, 0.1dB step
Local interface		LCD + control buttons
Remote management		Web NMS
Dimensions	mm	285 x 270 x 50
Weight	Kg	2.6

HTT 101

A versatile modern design, the HTT 101 offers an easy HDMI to COFDM modulation option for use in a wide range of professional applications.

APPLICATION

The HTT 101 is ideal for taking the feed from a High Definition Sky box to modulate into a hotel system.

CHARACTERISTICS

- Fully compatible bitrates.
- Powerful multiplex configuration.
- RF input combiner F type.
- Logical Channels Numbers (LCN).
- Excellent modulation quality MER > 42 dB.
- LCD display & local configuration.
- Well ventilated, pressed metal chassis.
- Backup/restore saved configurations.
- There is also a composite input.
- Programming is done from an easy to use built-in control panel, and includes LCN.



MODEL	HTT 101	
Reference	86526	
VIDEO ENCODING	H.264/AVC High Profile Level 4.0(HD)	
Input	HDMI x 1 + 1 (backup)	
Resolution	1920*1080_60P, 1920*1080_50P; 1920*1080_60i, 1920*1080_50i; 1280*720_60p, 1280*720_50P	
AUDIO ENCODING	MPEG1 Layer II	
Sample rate	KHz	48
Bit rate	Kbps	64, 96, 128, 192, 256, 320, 384
MODULATION STANDARD	EN300744	
FFT mode	2K, 8K	
Bandwidth	MHz	6, 7, 8
Constellation	QPSK, 16QAM, 64QAM	
Guard interval	1/4, 1/8, 1/16, 1/32	
FEC	1/2, 2/3, 3/4, 5/6, 7/8	
MER	dB	≥ 42
RF frequency	30~960 MHz, 1 KHz step	
RF output level	71~91 dBμV, 0.1dB step	
Local interface	LCD + control buttons	
Power supply	DC 12V	
Dimensions	mm	153 x 110 x 50
Weight	Kg	0,5

FMS A Series

Shielded SAT-IF stand alone multiswitches.

APPLICATION

For distributing one or two satellites signals in small and medium size installations. Each user receives both satellite and terrestrial signal by only one coaxial cable and any satellite polarisation can be selected from each user's receiver.

CHARACTERISTICS

- Star distribution of 4 or 8 satellite polarizations.
- Input for terrestrial signal, which can be selected in active or passive mode.
- 5-65 MHz return path.
- For 4, 8 or 16 users distributions.
- Control by voltage/tone from the user's receiver. Models with 8 inputs support also DiseqC2.0.
- The high selectivity of the input filters guarantee the maximum quality of the signal.

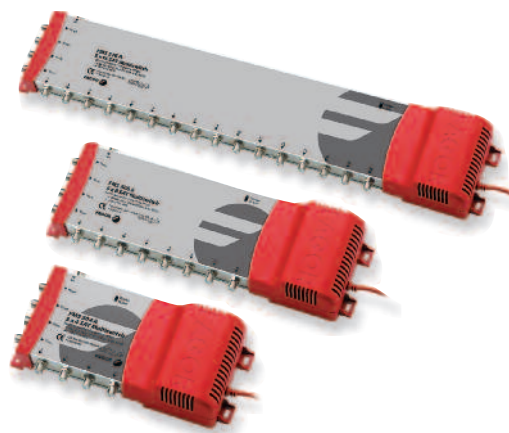

HEADENDS

FMS 516 A + MicroMATV book

- 4 pol + Terr
- 16 receivers

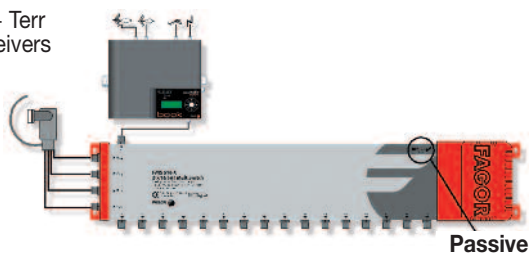

FMS 904 A

- 8 pol + Terr
- 4 receivers

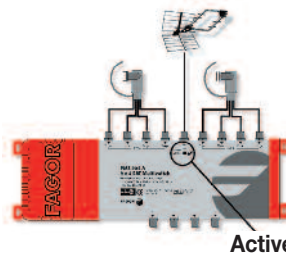

MODEL		FMS 504 A	FMS 508 A	FMS 512 A	FMS 516 A	FMS 904 A	FMS 908 A	FMS 912 A	FMS 916 A
Reference		86410	86411	86419	86412	86413	86414	86420	86415
Inputs		4 Sat. + 1 Terr				8 Sat. + 1 Terr			
Outputs		4	8	12	16	4	8	12	16
Frequency Range	Return Path Terr SAT	MHz		5 - 65 88 - 862 950 - 2150					
Gain	Return Path Terr Passive * Terr Active * SAT	dB		-15 -18 -20 -22 -16 -16 -20 -22 -17 -20 -22 -24 -19 -20 -22 -24 5 ± 2.0 2 ± 2.0 -2 ± 2.0 -1 ± 2.0 3 ± 2.0 3 ± 2.0 3 ± 2.0 4 ± 2.0 -4 ± 2.0 -6 ± 2.0 6 ± 2.0 2 ± 2.0 2 ± 2.0 1 ± 2.0 1 ± 2.0 0 ± 2.0					
Max. output level	Terr Active * SAT	DIN 45004B - 60 dB DIN 45004B - 35 dB		dBµv 90 105					
Rejection between inputs	Terr to SAT SAT to Terr SAT -SAT	dB		30 35 30					
Isolation between outputs		dB		30					
Polarisation control		13Vdc / 18Vdc • 0 / 22 KHz							
Satellite control		—				DiseqC2.0			
Max. LNBS current		mA				600 1000			
Input return losses		dB		10					
Output return losses		dB		10					
Connectors		F (h)							
Current consumption from receiver		mA				Max. 65 Max. 70			
Supply voltage		Vac							
Power consumption without LNB	Terr Passive * Terr Active *	W		230 ± 15% / 50 Hz 2,2 2,2 2,2 2,2 3,8 3,8 4,2 4,2 2,8 2,8 3,6 3,6 4,8 4,8 4,2 4,2					
Operating temperature range		°C							
Packing dimensions		mm		-10 a 55 285 x 131 x 63 357 x 131 x 63 458 x 131 x 63 558 x 131 x 63 357 x 131 x 63 357 x 131 x 63 458 x 131 x 63 558 x 131 x 63					
Weight		Kg		0,71 0,90 0,96 0,96 0,92 1,42 1,42 1,36					

* Terr Active or Passive selectable by switch..

FMS A Series

Shielded SAT-IF stand alone multiswitches. 16 SAT input + 1 Terrestrial input.

APPLICATION

For distributing four satellites signals in small and medium size installations. Each user receives both satellite and terrestrial signal by only one coaxial cable and any satellite polarisation can be selected from each user's receiver.

CHARACTERISTICS

- Star distribution of 16 satellite polarizations.
- Input for terrestrial signal, which can be selected in active or passive mode.
- 5-65 MHz return path.
- For 8, 12 or 16 users distributions.
- Control by voltage/tone from the user's receiver. Satellite selection through DiseqC 2.0.
- The high selectivity of the input filters guarantee the maximum quality of the signal.

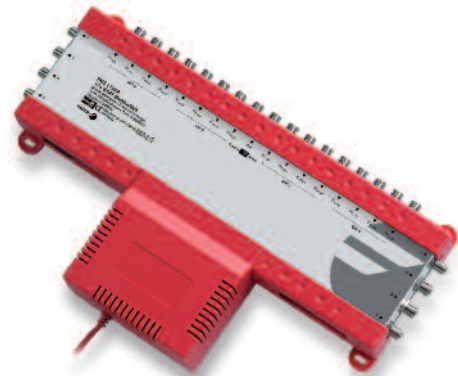

HEADENDS

FMS 1708 A

- 16 pol + Terr
- 8 receivers

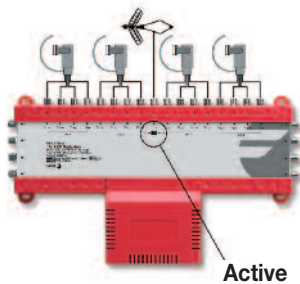

FMS 1716 A

- 16 pol + Terr
- 16 receivers

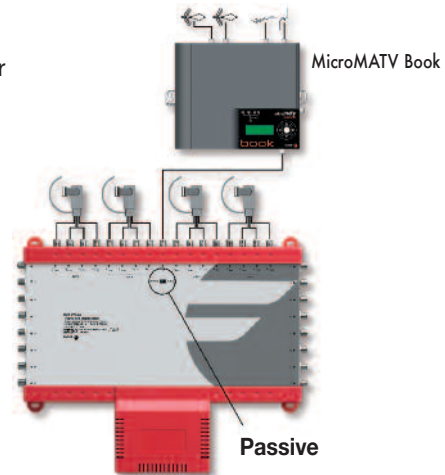

MODEL		FMS 1708 A	FMS 1712 A	FMS 1716 A
Reference		86421	86422	86423
Inputs		16 Sat. + 1 Terr		
Outputs		8	12	16
Frequency Range	Return Path Terr SAT		5 ÷ 65 88 ÷ 862 950 ÷ 2150	
Gain	Return Path Terr Passive * Terr Active * SAT	-22 -23 -2 ± 2.0 0 ± 2.0	-23 -28 -4 ± 2.0 0 ± 2.0	-26 -30 2 ± 2.0 0 ± 2.0
Max. output level	Terr Active* SAT	- 60 dB IM3 - 35 dB IM3	90 105	
Polarisation control		Vdc / 18 Vdc • 0 / 22 KHz		
Satellite control		DiseqC2.0		
Max. LNBS current			1.500	
Current consumption from receiver			Max. 100	
Supply voltage			230 ± 15% / 50 Hz	
Operating temperature range			-10 to 55	
Packing dimensions		400 x 240 x 70	400 x 330 x 70	400 x 330 x 70
Weight		1,660	2,355	2,385

* Terr Active or Passive selectable by switch.

FMC Series

SAT-IF cascadable multiswitches.
4, 8 & 16 SAT inputs + 1 Terrestrial input.

APPLICATION

For the distribution of satellite TV signal up to 16 polarities. Each user receives both satellite and terrestrial signal by only one coaxial cable and any satellite polarisation can be selected from each user's receiver.

CHARACTERISTICS

- Low cascading loss at high subscriber extensions.
- Cascade distribution of 4, 8 and 16 satellite polarizations.
- Input for terrestrial signal, compatible with terrestrial digital broadcast (DVB-T).
- Control by voltage/tone from the user's receiver. Satellite selection through DiSEqC 2.0.-2.1.
- The high selectivity of the input filters guarantees the maximum quality of the signal.
- Terminal multiswitches and amplifiers: power supply included.
- LNB Quattro & LNB Quad compatible.



HEADENDS

POWER SUPPLY WITH EUROPEAN PLUG



MODEL	SPS 1825
Referencia	86430
Output voltage	18 Vcc 2.5A
Input voltage	Vac 80-260

8 POLARITIES/ 48 SUBSCRIBERS

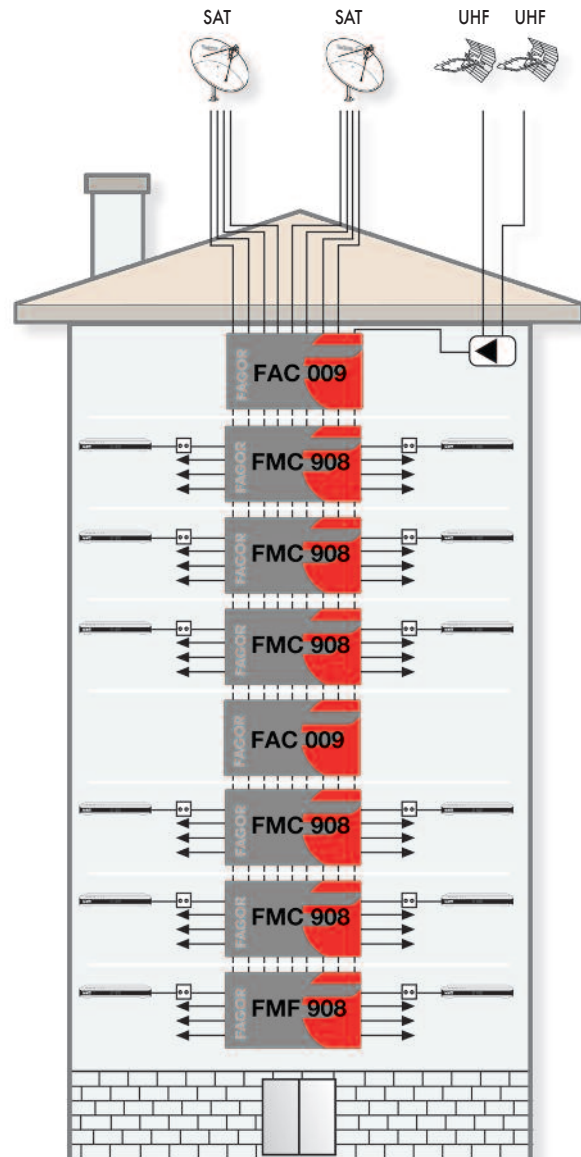

FMC Series

5 INPUT CASCADABLE SYSTEM

CASCADABLE MULTISWITCHES

MODEL			FMC 508	FMC 512	FMC 516	FMC 524	FMC 532
Reference			86432	86433	86434	86445	86446
Inputs			4 SAT + 1 TERR				
Subscriber outputs			8	12	16	24	32
Frequency Range	TERR SAT	MHz	47-870 950-2150				
Tap gain/loss	TERR SAT	dB	-3 ± 2 +5 ± 3	-5 ± 2 +6 ± 3	-5 ± 2 +6 ± 3	-5 ± 2 +6 ± 3	-5 ± 2 +6 ± 3
Cascade gain	TERR SAT	dB	-3 -1	-3 -1,5	-4 -2	-4 -2	-4 -2
Isolation	SAT-SAT	dB	>30	>35	>35	>35	>35
	SAT-TERR		>40	>40	>40	>40	>40
	OUT-OUT		>35	>35	>35	>35	>35
Max. output level (Ter.-60 dBIM3, SAT -35dB IM3)	TERR SAT	dBμV	90 102				
Sat. and polarity selection			13Vdc / 18Vdc • 0 / 22 KHz				
Max. current consumption (without LNB)			240				
Operating temperature range			-10 to 40				
Packing dimensions			220 x 250 x 50			220 x 500 x 50	
Weight			0,55	0,6	0,75	1,15	1,3

TERMINAL MULTISWITCHES

MODEL			FMF 508	FMF 512	FMF 516	FMF 524	FMF 532
Reference			86460	86461	86462	86463	86464
Inputs			4 SAT + 1 TERR				
Subscriber outputs			8	12	16	24	32
Frequency Range	TERR SAT	MHz	47-870 950-2150				
Tap gain/loss	TERR SAT	dB	-3 ± 2 +5 ± 3	-5 ± 2 +6 ± 3	-5 ± 2 +6 ± 3	-5 ± 2 +6 ± 3	-5 ± 2 +6 ± 3
Isolation	SAT-SAT	dB	>30	>35	>35	>35	>35
	SAT-TERR		>40	>40	>40	>40	>40
	OUT-OUT		>35	>35	>35	>35	>35
Max. output level (Ter.-60 dBIM3, SAT -35dB IM3)	TERR SAT	dBμV	90 102				
Sat. and polarity selection			13Vdc / 18Vdc • 0 / 22 KHz				
Max. current consumption (without LNB)			240				
Power supply			195-265Vac/18Vdc/2500mA				
Operating temperature range			-10 to 40				
Packing dimensions			220 x 250 x 50			220 x 500 x 50	
Weight			0,55	0,55	0,6	1,15	1,3

MODELO	HEADEND AMPLIFIER		SPLITTER		TAP-OFFS	
	FAC 005	FSP 005	FSP 005	FTP 505	FTP 510	FTP 510
Reference		86442	86451	86452	86453	86453
Inputs		4 SAT + 1 TERR				
Outputs		4 SAT + 1 TERR	2x5 (4 +1)	5 (4+1) + 5 (4+1)	5 (4+1) + 2x5 (4+1)	
Frequency Range	TERR SAT	MHz	47-870 950-2150			
Tap gain/loss	TERR SAT	dB	— —	— —	-12 -12	-12 -12
Cascade gain	TERR SAT	dB	-1 ± 1 22±1 (4dB tilt)	-3 -1,5	-4 -2	-4 -2
Gain regulation	TERR SAT	dB	20 20	— —	— —	— —
Isolation	SAT-SAT	dB	>33	>35	>35	>35
	SAT-TERR		>50	>35	>35	>35
	OUT-OUT		—	>20	>30	>30
Max. output level (Ter.-60 dBIM3, SAT -35dB IM3)	TERR SAT	dBμV	120 110	— —	— —	— —
Max. current consumption (without LNB)		mA	150	—	—	—
Power supply			18V 2.5A	—	—	—
Operating temperature range		°C	-10 to 40			
Packing dimensions		mm	220 x 250 x 50			
Weight		Kg	0,97	0,25	0,25	0,28

FMC Series

9 INPUT CASCADABLE SYSTEM

CASCADABLE MULTISWITCHES

MODEL			FMC 908	FMC 912	FMC 916	FMC 924	FMC932
Reference			86436	86437	86438	86447	86448
Inputs			8 SAT + 1 TERR				
Subscriber outputs			8	12	16	24	32
Frequency Range	TERR SAT	MHz	47-870 950-2150				
Tap gain/loss	TERR SAT	dB	-3 ± 2 +5 ± 4	-5 ± 2 +6 ± 4	-5 ± 2 +4 ± 4	-5 ± 2 +4 ± 4	-5 ± 2 +4 ± 4
Cascade gain	TERR SAT	dB	-3 -1,5	-3 -2	-4 -3	-3 -2	-4 -3
Isolation	SAT-SAT SAT-TERR OUT-OUT	dB	>37 >35 >35	>36 >37 >35	>38 >35 >35	>36 >47 >35	>38 >35 >35
Max. output level (Ter.-60 dBIM3, SAT -35dB IM3)	TERR SAT	dBμV	90 102				
Sat. and polarity selection			DiSEqC 2.0-2.1				
Max. current consumption (without LNB)			200			300	
Operating temperature range			- 10 to 40				
Packing dimensions			235 x 315 x 50			235 x 630 x 50	
Weight			0,52	0,65	0,77	1,12	1,37

TERMINAL MULTISWITCHES

MODEL			FMF 908	FMF 912	FMF 916	FMF 924	FMF 932
Reference			86465	86466	86467	86468	86469
Inputs			8 SAT + 1 TERR				
Subscriber outputs			8	12	16	24	32
Frequency Range	TERR SAT	MHz	47-870 950-2150				
Tap gain/loss	TERR SAT	dB	-3 ± 2 +5 ± 4	-5 ± 2 +6 ± 4	-5 ± 2 +4 ± 4	-5 ± 2 +4 ± 4	-5 ± 2 +4 ± 4
Isolation	SAT-SAT SAT-TERR OUT-OUT	dB	>37 >35 >35	>36 >37 >35	>38 >35 >35	>36 >37 >35	>38 >35 >35
Max. output level (Ter.-60 dBIM3, SAT -35dB IM3)	TERR SAT	dBμV	90 102				
Sat. and polarity selection			DiSEqC 2.0-2.1				
Max. current consumption (without LNB)			200			300	
Power supply			195-265Vac/18Vdc/2500mA				
Operating temperature range			- 10 to 40				
Packing dimensions			235 x 315 x 50			235 x 630 x 50	
Weight			0,52	0,65	0,77	1,12	1,37

MODEL			HEADEND AMPLIFIER	SPLITTER	TAP-OFFS	
			FAC 009	FSP 009	FTP 909	FTP 918
Reference			86443	86451	86455	86456
Inputs			8 SAT + 1 TERR			
Outputs			8 SAT + 1 TERR	2x9 (8 +1)	8 (8+1) + 9 (8+1)	9 (8+1) + 2x9 (8+1)
Frequency Range	TERR SAT	MHz	47-870 950-2150			
Tap gain/loss	TERR SAT	dB	— —	— —	- 12 - 12	- 12 - 12
Cascade gain	TERR SAT	dB	- 1 ± 1 22±1 (4dB tilt)	- 4 - 4	- 1,5 - 0,5	- 2 - 1
Gain regulation	TERR SAT	dB	20 20	— —	— —	— —
Isolation	SAT-SAT SAT-TERR OUT-OUT	dB	>33 >50 —	>35 >35 >20	>35 >35 >30	>35 >35 >30
Max. output level (Ter.-60 dBIM3, SAT -35dB IM3)	TERR SAT	dBμV	120 110	— —	— —	— —
Max. current consumption (without LNB)			300	—	—	—
Power supply			18V 2,5A	—	—	—
Operating temperature range			- 10 to 40			
Packing dimensions			235 x 315 x 50			
Weight			1,21	0,4	0,4	0,4

FMC Series

17 INPUT CASCADABLE SYSTEM

CASCADABLE MULTISWITCHES

MODEL			FMC 1708	FMC 1712	FMC 1716	FMC 1724	FMC 1732
Reference			86439	86440	86441	86449	86450
Inputs			16 SAT + 1 TERR				
Subscriber outputs			8	12	16	24	32
Frequency Range	TERR SAT	MHz	47-870 950-2150				
Tap gain/loss	TERR SAT	dB	-3 ± 2 +5 ± 4	-5 ± 2 +5 ± 4	-5 ± 2 +5 ± 4	-5 ± 2 +5 ± 4	-5 ± 2 +5 ± 4
Cascade gain	TERR SAT	dB	-3 -1,5	-3 -2	-4 -2,5	-3 -2	-4 -2,5
Isolation	SAT-SAT	dB	>35	>33	>32	>33	>32
	SAT-TERR		>40	>40	>40	>40	>40
	OUT-OUT		>33	>36	>36	>36	>36
Max. output level (Ter.-60 dBIM3, SAT -35dB IM3)	TERR SAT	dBμV	90 102				
Sat. and polarity selection			DiSEqC 2.0-2.1				
Max. current consumption (without LNB)			200			300	
Operating temperature range			- 10 to 40				
Packing dimensions			300 x 415 x 50			600 x 415 x 50	
Weight			0,55	1,21	1,51	2,15	2,67

TERMINAL MULTISWITCHES

MODEL			FMF 1708	FMF 1712	FMF 1716	FMF 1724	FMF 1732
Reference			86470	86471	86472	86473	86474
Inputs			16 SAT + 1 TERR				
Subscriber outputs			8	12	16	24	32
Frequency Range	TERR SAT	MHz	47-870 950-2150				
Tap gain/loss	TERR SAT	dB	-3 ± 2 +5 ± 4	-5 ± 2 +5 ± 4	-5 ± 2 +5 ± 4	-5 ± 2 +5 ± 4	-5 ± 2 +5 ± 4
Isolation	SAT-SAT	dB	>37	>33	>32	>33	>32
	SAT-TERR		>35	>40	>40	>40	>40
	OUT-OUT		>35	>36	>36	>36	>36
Max. output level (Ter.-60 dBIM3, SAT -35dB IM3)	TERR SAT	dBμV	90 102				
Sat. and polarity selection			DiSEqC 2.0-2.1				
Max. current consumption (without LNB)			200			300	
Power supply			195-265Vac/18Vdc/2500mA				
Operating temperature range			- 10 to 40				
Packing dimensions			300 x 415 x 50			600 x 415 x 50	
Weight			0,97	1,21	1,51	2,15	2,67

MODEL	HEADEND AMPLIFIER		SPLITTER		TAP-OFFS	
	FAC 017	FSP 005	FTP 1717	FTP 1734		
Reference		86444	86457	86458	86459	
Inputs		16 SAT + 1 TERR				
Outputs		16 SAT + 1 TERR	2x17	17 + 17	17+ 2x17	
Frequency Range	TERR SAT	MHz	47-870 950-2150			
Tap gain/loss	TERR SAT	dB	—	—	-12 -12	-12 -12
Cascade gain	TERR SAT	dB	-1 ± 1 22±1 (4dB tilt)	-4 -4	-1,5 -0,5	-2 -1
Gain regulation	TERR SAT	dB	20 20	—	—	—
Isolation	SAT-SAT	dB	>33	>35	>35	>35
	SAT-TERR		>50	>35	>35	>35
	OUT-OUT		—	>20	>30	>30
Max. output level (Ter.-60 dBIM3, SAT -35dB IM3)	TERR SAT	dBμV	120 110	— —	— —	— —
Max. current consumption (without LNB)		mA	510	—	—	—
Power supply			18V 2.5A	—	—	—
Operating temperature range		°C	- 10 to 40			
Packing dimensions		mm	150 x 500 x 50			
Weight		Kg	1,51	0,6	0,6	0,6

APPLICATION EXAMPLES

HEADENDS

SABAL Series
HA 405 Multiband Amplifier + SAB

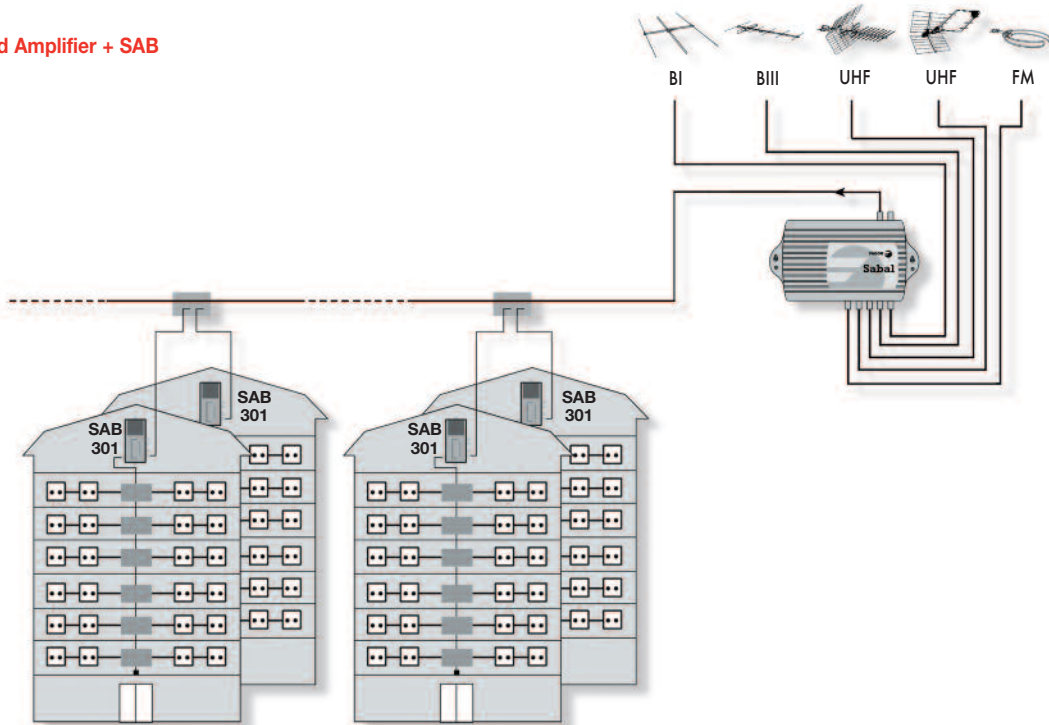

FMS 904 A

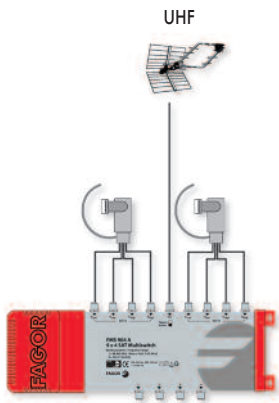

FMS 516 A

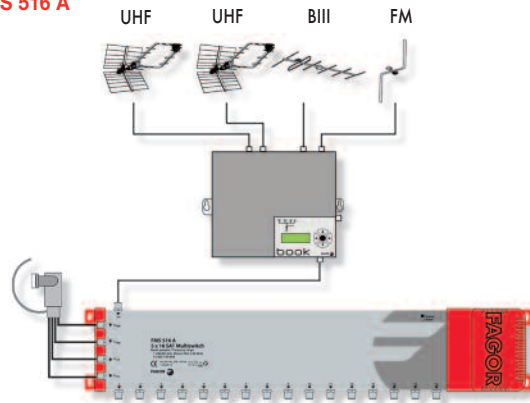

Application Example Summa Basic series

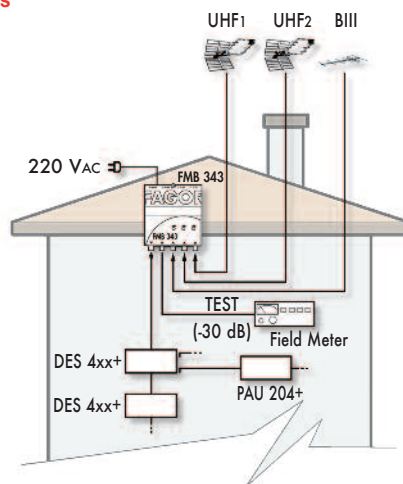

LBF-E Series

High rejection filter for outdoors.

APPLICATION

LTE protection filter for 4G (791 MHz-862 MHz) and GSM + TETRA (870 MHz-960 MHz) signals received by the antenna.

CHARACTERISTICS

- Shielded metal box with F connectors that assures a high degree of shielding.
- Metallic box housed in a plastic one, ready to be installed.
- Allows DC pass between any output.
- High rejection against interfering signals.
- Suitable for the upcoming LTE/4G signals.



AMPLIFICATION



MODEL	LBF -E 766	LBF -E 782
Reference	85057	85055
N° of input / output	1/1	1/1
Band pass	DC - CH 57	DC - CH 59
Attenuation in band	1	1
LTE rejection (791-862 MHz)	60	60
GSM-TETRA rejection (870-960 MHz)	60	60
DC pass	YES / 300	
Packing dimensions	100 x 87 x 45	
Operating Temperature Range	-10 °C - +50	
Weight	0,16	

LBF E-766

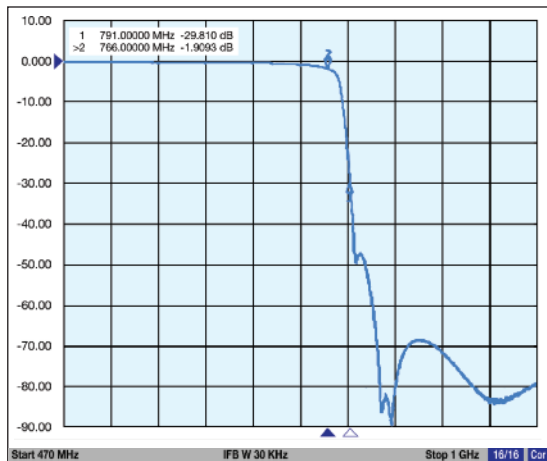

LBF E-782

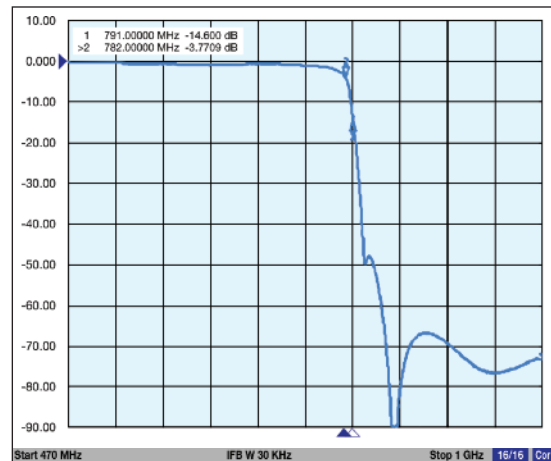

LBF-C Series

High rejection cavity filter to protect community installations against LTE signals in the band 791-862 MHz.

CHARACTERISTICS

- High selectivity, which guarantees a great rejection to interfering signals, without affecting the TV channels in the high band.
- Protects against strong interfering signals (up to 1 W), providing reliable TV reception to installations close to LTE signal repeaters.
- Provided in 2 modules assembled on a little frame, to be easily adapted to the NEXUM series frame. It can be also assembled on the wall.
- DC pass to feed antenna pre-amplifiers.

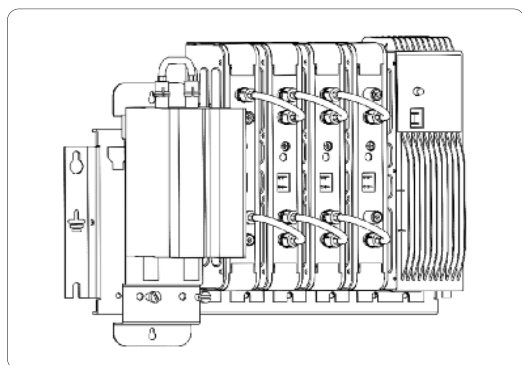

AMPLIFICATION

MODEL		LBF C-790
Reference		85064
N° of input / output		1/1
Band pass	MHz	DC - 790*
Attenuation in band	(470-778 MHz) (778-786 MHz) dB	<1,5 <2
LTE rejection	(791-862 MHz) (793-862 MHz) dB	>15 >40
DC pass	mA	Yes / 300
Packing dimensions	mm	250 x 125 x 60
Operating Temperature Range	°C	-10 °C – +50
Weight	Kg	0,7

* Other frequencies upon request.

LBF-C FREQUENCY RESPONSE

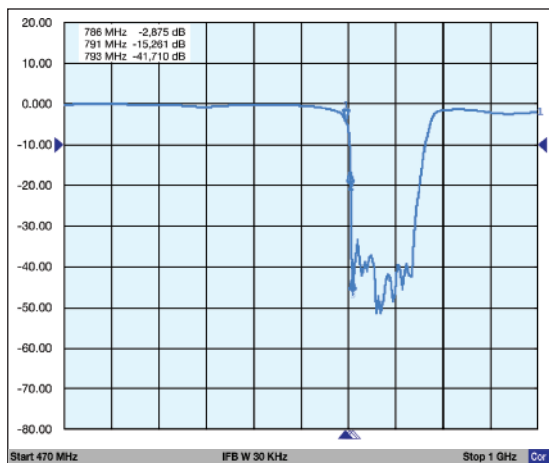

COMPARISON WITH COMMON FILTER FREQUENCY RESPONSE

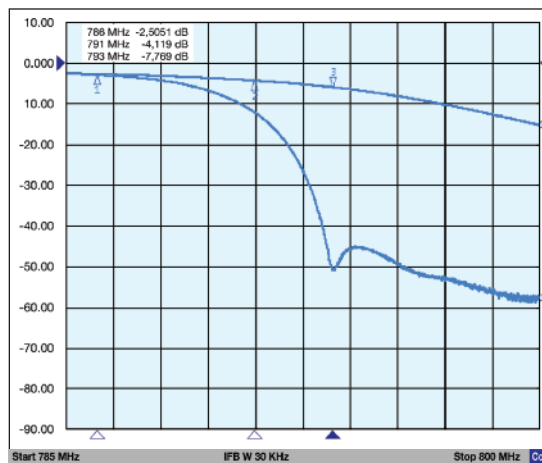

AMB 800 Series

Professional mast amplifiers, immune to all signals from other services which share the radioelectric spectrum, such as mobile phones, wireless transmissions, terrestrial communications....

APPLICATION

Suitable for individual systems or small installations, with high sensitivity and output power (114 dB μ V), the AMB 800 is a heavy-duty amplifier, ideal for future applications according to new Digital Terrestrial TV (DTT) requirements. It is prepared to process both analogue and digital signals during the migration towards DTT.

CHARACTERISTICS

- Very low noise figure and independent from gain regulation
- The mechanical solution guarantees an exceptional immunity against noise invasion, a critical aspect for DTT reception.
- 3 Notch filters can be adjusted over the whole UHF band, or even in their extremes to achieve an additional rejection to unwanted signals.
- F connectors.
- Output level Test.
- Wide range of input levels.
- AMB 802 DC, AMB 836 with DC pass for pre-amplifiers.



AMPLIFICATION

Supply voltage	24 \pm 10% Vdc
Operating temperature range	- 20 \div 60° C
Selective equalization	3 tuneable UHF filters in main amplification line
Notch 1	390 MHz
	660 MHz
Notch 2	445 MHz
	720 MHz
Notch 3	600 MHz
	975 MHz

MODEL	AMB 801	AMB 802 DC**	AMB 810		AMB 820		AMB 823		
Reference	36011	36012	36010		36020		36023		
Nbr. of inputs	1				2				
Bands	UHF	UHF	BI;BIII	UHF	BI;BIII	UHF	BI÷FM;BIII	UHF	
Gain	38	28	28	38	28	38	28	38	
Gain regulation	15	15	25	15	25	15	25	15	
Output level DIN 45004B-60	114								
Input/output impedance	75								
Noise figure	3	4	5	3	5	3	5	3	
Rejection out of band	Compliance with EN 50083-2 "Antenna Input Resistance" • Internal immunity against unwanted signals from out of band								
Test output	-30 dB (from main output)								
Current drawn	93	70	93						
Packing dimensions	170 x 105 x 50								
Weight	0,355								

MODEL	AMB 824		AMB 830			AMB 831		
Reference	36024		36030			36031		
Nbr. of inputs	2		3					
Bands	FM	BIII;UHF	BI÷FM;BIII	UHF	UHF	BI;BIII	UHF	UHF
Gain	28	28/38	28	38	38	28	38	38
Gain regulation	25	25/15	25	15	15	25	15	15
Output level DIN 45004B-60	114							
Input/output impedance	75							
Noise figure	5	3/5	5	6	6	5	6	6
Rejection out of band	Compliance with EN 50083-2 "Antenna Input Resistance" • Internal immunity against unwanted signals from out of band							
Test output	-30 dB (from main output)							
Current drawn	100		93					
Packing dimensions	170 x 105 x 50							
Weight	0,355							

AMB 800 Series

AMPLIFICATION

MODEL	AMB 835			AMB 836*			AMB 840			
Reference	36035			36047			36055			
Nbr. of inputs	3			3			4			
Bands	BI÷FM	BIII	UHF	FM	BIII-DAB	UHF	BI÷FM;BIII	UHF	UHF1	UHF2
Gain	28	28	38	18	18	28	28	34	33	33
Gain regulation	25	25	15	15	15	15	25	15	15	15
Output level DIN 45004B-60	114									
Input/output impedance	75									
Noise figure	5	5	3	6	6	4	5	6	7	7
Rejection out of band	Compliance with EN 50083-2 "Antenna Input Resistance" • Internal immunity against unwanted signals from out of band									
Test output	-30 dB (from main output)									
Current drawn	93			70			100			
Packing dimensions	170 x 105 x 50									
Weight	0,355									

U₁: 21...49
 U₂: 50...69
 * DC pass 24 Vdc, 40 mA at UHF input.

MODEL	AMB 810 D		AMB 820 D		AMB 835 D		
Reference	36413		36424		36435		
Nbr. of inputs	1		2		3		
Bands	BI;BIII	UHF	BI;BIII	UHF	BI÷FM	BIII	UHF
Gain	28	38	28	38	28	28	38
Gain regulation	25	15	25	15	25	25	15
Output level DIN 45004B-60	114						
Input/output impedance	75						
Noise figure	5	3	5	3	5	5	3
Rejection out of band	Compliance with EN 50083-2 "Antenna Input Resistance" • Internal immunity against unwanted signals from out of band						
Test output	-30 dB (from main output)						
Current drawn	93						
Packing dimensions	170 x 105 x 50						
Weight	0,355						

MODEL	12 V		12 V			12 V			
	AMB 820 S		AMB 832 S			AMB 840 S			
Reference	36070		36071			36072			
Nbr. of inputs	2		3			4			
Bands	BI;BIII	UHF	BI;BIII	UHF	UHF	BI;BIII	BIV	BV	UHF
Gain	27	27	27	27	27	27	27	27	27
Gain regulation	15	15	15	15	15	15	15	15	15
Output level DIN 45004B-60	108	114	108	114		108	114		
Input/output impedance	75		75			75			
Noise figure	6	4	6	6		6	7	7	6
DC Pass 12V	no		no	40	40	no			
Rejection out of band	Compliance with EN 50083-2 "Antenna Input Resistance" • Internal immunity								
Test output	-30 dB (from main output)					—			
Supply voltage	12 ± 10%								
Current drawn	210		210			210			
Packing dimensions	170 x 105 x 50								
Weight	0,355								

KITS AVAILABLE:

REF	KIT	COMPOSITION
36415	AMB 811 DK	AMB 801 D + FA 152
36414	AMB 802 DK	AMB 820 D + FA 152
36427	AMB 822 DK	AMB 835 D + FA 152
36438	AMB 838 DK	AMB 830 D + FA 152
36436	AMB 836 DK	AMB 836 D + FA 152
36006	AMB 836 K	AMB 836 + FA 152
36003	AMB 802 K	AMB 802 DC + FA 152
36008	AMB 838 K	AMB 830 + FA 152
36009	AMB 822 K	AMB 820 + FA 152

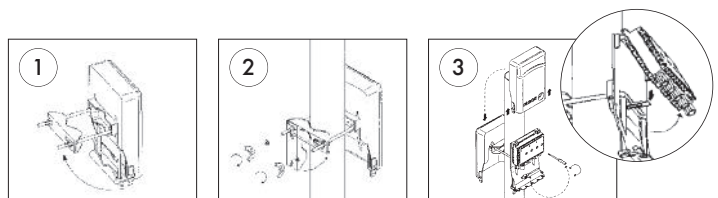

AML Series

Professional mast band amplifiers, LTE protected immune to all signals from other services which share the radioelectric spectrum, such as mobile phones, wireless transmissions, terrestrial communications...

APPLICATION

Suitable for individual systems or small installations, with high sensitivity and output power (114 dBμV), the AML is a heavy-duty amplifier, totally adapted to the new LTE environment.

CHARACTERISTICS

- Switchable dc pass for uhf inputs.
- Low noise figure in the high gain models.
- Allows high input levels in the low gain models
- LTE ready.
- Very low noise figure and independent from gain regulation.
- The mechanical solution guarantees an exceptional immunity against noise invasion, a critical aspect for DTT reception.
- 3 Notch filters can be adjusted over the whole UHF band, or even in their extremes to achieve an additional rejection to unwanted signals.
- F connectors.
- Output level Test.



AMPLIFICATION



Supply voltage	24 ± 10% Vdc
Operating temperature range	- 20... +60 °C
Selective equalization	3 tuneable UHF filters in main amplification line
Notch 1	390 MHz 12 660 MHz 7
Notch 2	445 MHz 16 720 MHz 7
Notch 3	600 MHz 4 975 MHz 11

MODEL	AML 210		AML 230				AML 240				AML 410		AML 430				AML 440				
Reference	36601		36603				36604				36611		36613				36614				
Nbr. of inputs	1		3				4				1		3				4				
Bands	UHF		FM	BIII-DAB		UHF	FM	BIII-DAB		UHF	UHF	UHF	FM	BIII-DAB		UHF	FM	BIII-DAB		UHF	UHF
Gain	dB		25	15	15	25	15	15	15	25	25	38	28	28	38	28	28	28	38	38	38
Gain regulation	dB		15	20	20	15	20	20	15	15	15	20	20	15	20	20	15	20	15	15	15
Output level DIN 45004B-60	dBμV		108								114										
Noise figure	dB		3	8	8	4	8	8	7	7	3	7	8	3	7	8	6	6	6	6	6
Rejection out of band	dB		Compliance with EN 50083-2 "Antenna Input Resistance", LTE Ready																		
Test output	dB		-30				—				-30				—						
Consumption	mA		50								80										
DC pass	mA		45	—		45	—		45	45	—		45	—		45	—		45	—	
Packing dimensions	mm		170 x 105 x 50																		
Weight	Kg		0,355																		

KITS AVAILABLE:

REF	KIT	COMPOSITION
36621	AML 210 K	AML 210 + FA 152
36623	AML 230 K	AML 230 + FA 152
36624	AML 240 K	AML 240 + FA 152
36631	AML 410 K	AML 410 + FA 152
36633	AML 430 K	AML 430 + FA 152
36634	AML 440 K	AML 440 + FA 152

AMB 700 Series

A new concept in mast amplifiers. Both models include a different combination of band pass and stop band filters, configurable upon request on the factory, enabling an exceptional operation in a reception sites where two UHF antennas are required. For reception sites just in the border of the coverage area, a switchable DC power in both inputs, enable the use antennas with active dipoles. Depending of the cable run and the numbers of outlets to be feed we offer two models, AMB 700 or AMB 701 with different gain.

APPLICATION

Specially designed for DTT reception.

CHARACTERISTICS

- Gain regulation independent of the noise figure.
- Exceptional protection against ingress noise.
- High screening mechanical concept.
- F type connectors.
- Extra operational input level range.
- Keeps unaffected the antenna signal quality achieved for the antenna system directivity.
- Applicable in areas of overlapping coverage in SFN.



Supply voltage	24 ± 10% Vdc
Operating temperature range	-20 ÷ 60 °C

MODEL	AMB 700				AMB 701			
Reference	365xx*							
N° of inputs	4							
Bands	FM 88 ÷ 108	BIII - DAB 174 ÷ 230	UHF1 (see Fig. 1)	UHF2 (see Fig. 1)	FM 88 ÷ 108	BIII - DAB 174 ÷ 230	UHF1 (see Fig. 1)	UHF2 (see Fig. 1)
Gain	15	20	26	26	15	26	36	36
Gain regulation	20	20	15	15	20	20	15	15
Output level DIN 45004B-60	106	106	111		106	106	111	
Input / output impedance	75							
Noise figure	4	4	4	4	4	4	3	3
Selectivity	15 dB, band filters @ C ± 3 (see Fig. 1) 12 dB, band filters @ Ch. ± 4							
Rejection out of band	Compliance with EN 50083 -2 "Antenna Input Resistance"							
Supply voltage	24 ± 10%							
Consumption	70				70			
DC pass	—	—	30	30	—	—	30	30
Dimensions	170 x 105 x 50							
Weight	0,355							

* Indicate the channels to be received by each UHF input.

AMB 700

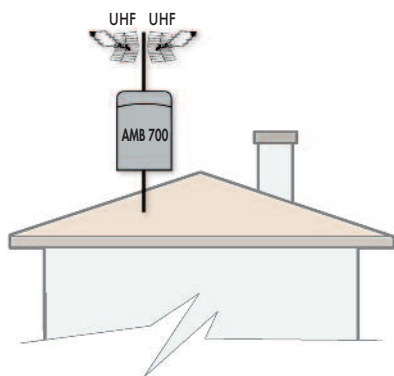

¿How to choose the most convenient amplifier?

1. Select the model of amplifiers depending on the type of filter: split band, channel pass and band pass.
2. After selecting the model, you must define the channels you want to receive.

MODEL	TYPE OF FILTER	CHANNELS TO BE DEFINED
1	SPLIT BAND 	UHF 1 C1=... UHF 2 C2=... - 69
2	CHANNEL PASS 	UHF 1 C=... UHF 2 Rest of band
3	BAND PASS 	UHF 1 C1= ...; UHF 2 Rest of band

AMPLIFICATION

AMB 200 K Series

Kit made up of a mast amplifier + power supply, specially designed to receive DTT signals with maximum quality.

APPLICATION

Suitable for individual systems or small installations.

CHARACTERISTICS

Amplifier:

- Separate level adjustment for each input.
- Low noise figure.
- "F" type connectors.
- Circuit housed in a shielded metal box that offers a high degree of immunity against radio-electric interference.

Power supply:

- Two outputs in a shielded circuit.
- Low consumption.
- Small size.
- Protected against short-circuits.
- With ON indicator led.



AMB 212 DK	36412
AMB 222 DK	36423
AMB 223 DK	36416

Packing dimensions	112 x 112 x 98 mm
Weight	0,5 Kg

AMPLIFIER

MODEL	12 V				12 V					
	AMB 212 K	AMB 222 K		AMB 223 K	AMB 224 SK		AMB 232 SK			
Reference	36404	36402		36403	36410		36411			
N°. of inputs	1	2				3				
Bands	BIII; UHF	BIII	UHF	BIII	UHF	BI; BIII; UHF	UHF	BI; BIII	UHF	UHF
Gain	20; 27	20	27	28	36	27		20	27	
Gain regulation		VHF 15 / UHF 15								
Noise figure	6; 4	6	4	6	4	6	6	6	6	
Return losses		-10								
Output level DIN 45004B - 60		110								
Input/output impedance		75								
Current drawn		75		97		100		100		
Supply voltage		24 ± 10%				12 ± 10%				
Operating temperature		-20 ÷ 60								

POWER SUPPLY

MODEL	12 V	
	FK 02	FK 02 S
Reference	66102	66103
Output voltage	24 ± 10%	12 ± 10%
Output current	100	150
N°. of outputs	2	
Through losses	4	
Return losses	-10	
Input-output impedance	75	
Input voltage	195 ÷ 265	
Operating temperature	0 ÷ 50	

FA Series

Power supply for mast amplifiers.

APPLICATION

Individual systems and small installations. Compatible with the requirements for Digital Terrestrial TV and High Definition TV.

CHARACTERISTICS

- High performance switched power supply, which provides a high output current with less consumption.
- Modern design and small size, making it easier to install.
- "F"-type connectors.
- The 4-output FA 154 model avoids having to include an external splitter in installations with up to 4 connections.
- Protected against short-circuits.
- With an ON indicator led.



Supply voltage	195 ÷ 265 Vac
Operating temperature	0 ÷ 50 °C

12 V

MODEL	FA 152	FA 154	FA 302 S	
Reference	66106	66107	66108	
Number of outputs	2	4	2	
Frequency range	MHz	5 ÷ 862		
Through losses	dB	4	7	4
Output voltage	Vdc	24 ± 10%		12 ± 10%
Max. output current	mA	150		200
Input / output impedance	Ω	75		
Packing dimensions	mm	140 x 97 x 51		
Weight	Kg	0,26	0,36	0,26

AMB 700 + FA 152

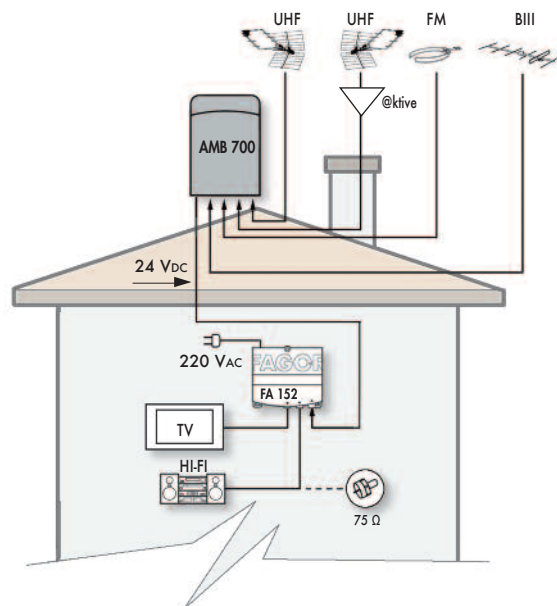

AMPLIFICATION

AD 420 Plus-DC / AD 540 Plus

Self-powered broadband amplifier for indoor use.

APPLICATION

Suitable for individual digital terrestrial TV installations with several TV sets located away from the main socket.

CHARACTERISTICS

- Circuit in metal box, with high degree of shielding.
- Switching power supply, which reduces consumption and inner temperature and guarantees a long life product.
- Modern and reduce-sized design, that allows an easy installation.
- AD 420 Plus: independent gain regulation in UHF and VHF.
- AD 540 Plus: Slope gain to compensate the coaxial cable losses.



AMPLIFICATION

MODEL		AD 420 Plus	AD 420 Plus DC	AD 540 Plus
Supply voltage	Vac	195 ÷ 265		
Power consumption	W	1,5		
Operating temperature range	°C	0 ÷ 50		

MODEL		AD 420 Plus		AD 420 Plus DC		AD 540 Plus
Reference		36422		36419		36426
Band coverage		VHF 40 ÷ 318	UHF 470 ÷ 862	VHF 40 ÷ 318	UHF 470 ÷ 862	47 ÷ 862
Gain	dB	20	22	20	22	16 ÷ 20 (47 ÷ 862 MHz)
Regulation	dB	17	15	17	15	16
Noise figure	dB	7	5	7	5	4
Number of output		2				4
Max. output level	dBµV	100				
Input/output impedance	Ω	75				
DC pass for previous		—		12V / 100 mA		—
Packing dimensions	mm	107 x 48 x 138 (+30)				
Weight	Kg	0,29				0,30

AD 420 Plus

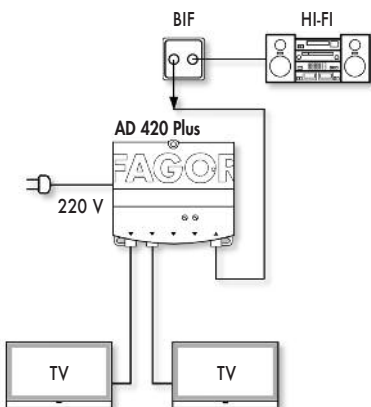

AD 420 Plus DC

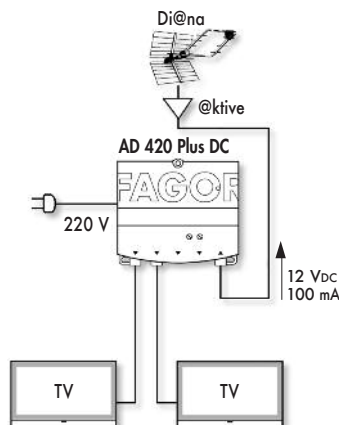

AD 540 Plus

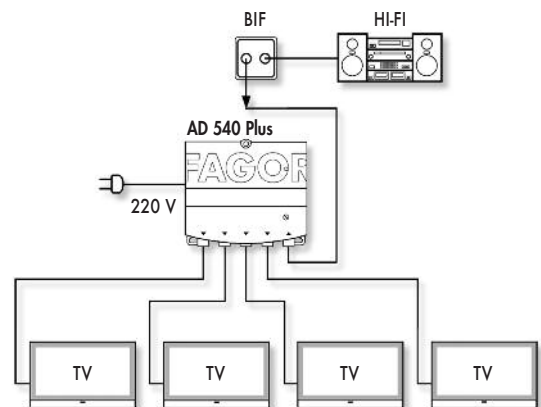

AD 1000

Self-powered broadband amplifier for indoor use.

AD 1000: amplifies signals from 47 to 862 MHz, and allows return path (from 5 to 30 MHz).

AD 1000 A: amplifies signals from 87 to 862 MHz.

APPLICATION

Suitable for individual digital terrestrial TV installations. The models are compatible with CATVs operators.

CHARACTERISTICS

- Gain control
- It has slope regulation to compensate the losses due to coaxial cable attenuation. Incorporate an equalization control.
- Two independent outputs, the second one attenuated 10 dB with respect to the first one.
- The circuit is housed in a zamak box that ensures a high level of shielding.



MODEL	AD 1000	AD 1000 A
Supply voltage	230 Vac +15% -10%	
Power consumption	W	7
Operating temperature range	°C	0 ÷ 50

MODEL	AD 1000	AD 1000 A
Reference	36100	36101
Number of inputs	1	
Number of outputs	2	
Frequency range	87 ÷ 862	
Gain	dB	
Max. output level DIN 45004B, -60 dBc	dBμV	
Input / output return losses	dB	
Gain regulation	dB	
Tilt regulation	dB	
Noise figure	dB	
Input / output impedance	Ω	
Return path frequency range	5 ÷ 30	5 ÷ 65
Return path through loss	dB	
Input / output connectors	F (f)	
Packing dimensions	mm	
Weight	Kg	

Indoor amplification RF

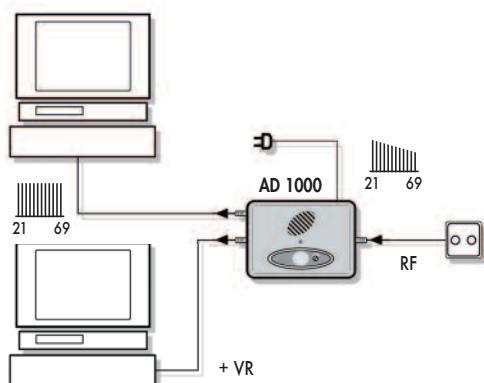

AD 2300 / AD 4300

Self-powered broadband amplifier for indoor use.

APPLICATION

Suitable for individual digital terrestrial TV installations with several TV sets located away from the main socket.

CHARACTERISTICS

- The circuit is housed in a zamak box that ensures a high level of shielding.
- Switching power supply, which reduces consumption and inner temperature and guarantees a long life product.
- Independent regulation
- Allows DC pass between any output.
- AD 2300: it has two independent outputs, the second one attenuated 10 dB with respect to the first one.
- AD 4300: it has 4 independent outputs. LTE compatible.



AMPLIFICATION

MODEL		AD 2300	AD 4300
Supply voltage	Vac	195 - 265	
Power consumption	W	5,5 VA	2,7
Operating temperature range	°C	0 ÷ 50	

MODEL	AD 2300				AD 4300			
Reference	36230				36231			
Number of inputs	1							
Number of outputs	2				4			
Frequency range	MHz		MHz		MHz		MHz	
	RF 47 ÷ 862		SAT 950 ÷ 2150		RF 47 ÷ 790		SAT 950 ÷ 2150	
Gain	dB		dB		dB		dB	
• Output 1	16	20	23	30	17		27	
• Output 2	4	8	13	20				
Max. output level DIN 4500 4B*	dBµV		dBµV		dBµV		dBµV	
	108 (Output 1) 96 (Output 2)		114 (Output 1) 104 (Output 2)		105		105	
Gain regulation	dB		—		20			
Impedance	Ω							
	75							
Return path through loss	dB				dB			
	3,5 (Output 1)				10			
Input / output connectors	F(f)							
Max. current drawn	A							
	0,5							
DC pass, 22 KHz, DiSEqC	YES ALL OUTPUTS							
Packing dimensions	mm				mm			
	165 x 92 x 60				148 x 130 x 50			
Weight	Kg				Kg			
	0,4				0,3			

* 950 ÷ 2300 MHz: IM3 at -35 dB
47 ÷ 862 MHz: IM3 at -60 dB

Indoor amplification (RF & 1st IF SAT)

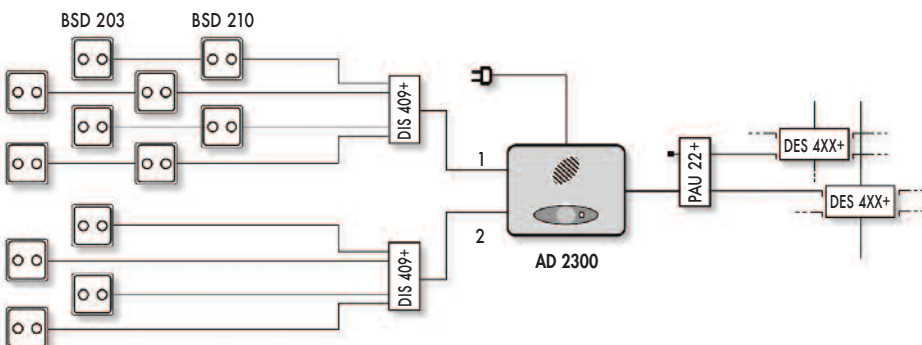

AD 4300

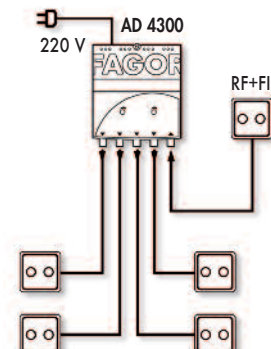

MOD 500 N Series

Self-powered modulator which generates an RF channel with the Audio and Video information coming from a Video, DVD, IRD, video door entry system, security cameras, etc.

APPLICATIONS

This modulator enables the reception of a signal coming from a receiver with Audio and Video output, on a TV set without Audio and Video input.

The antenna signal from an outlet socket can be combined with a newly generated channel and both are delivered at the output, thus enabling their coaxial cable distribution throughout the dwelling.

CHARACTERISTICS

- Double side band modulation, allowing one channel spacing operation.
- Compact design, making it easy to install.
- The output channel is easily programmed by two buttons and an alphanumerical display.
- Audio volume can be adjusted to be equalised with the volume of other programmes.
- Incorporates a video-test bar generator making TV tuning easier.
- Multi-standard and multi-band, with one single model covering all standards and channels.
- A PLL circuit ensures high stability of the output channel.



Supply voltage	198 ÷ 250 Vac
Consumption	2,5 VA
Operating temperature range	0 ÷ 50° C

MODEL		MOD 500 N
Reference		86521
Output frequency	MHz	47÷862 BI E2-4 BIII E5 ÷ E12 BS S11 ÷ S20 UHF 21 ÷ 69
Output level	dBµv	60 ÷ 75 (adjustable)
Passage band	MHz	47 ÷ 2150
Insertion losses	dB	47 ÷ 862 MHz : 2,5 862 ÷ 2150 MHz : 4
Video input level	Vpp	1
Audio input level	Vpp	0,15 ÷ 0,77
Connectors		RF: F (f) VIDEO / AUDIO: RCA (f)
Packing dimensions	mm	110 x 50 x 134
Weight	kg	0,3

APPLICATION EXAMPLE

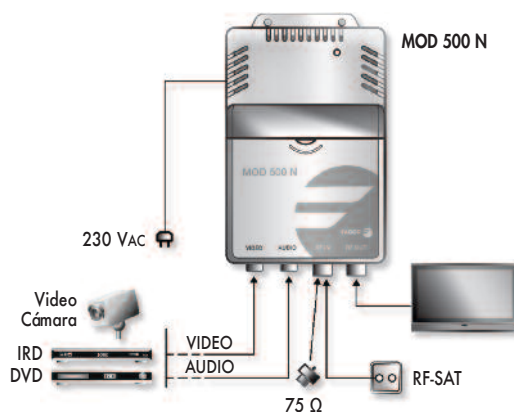

SABAL Series

Amplifiers specially designed for the distribution of the RF and 1st IF SAT signal.

APPLICATION

Designed to work under adverse weather conditions, where a robust amplifier is needed.

CHARACTERISTICS

- Their circuit is integrated in a Zamak box, which ensures correct operation of the amplifier.
- Allow return path operation and have slope control for the direct way.
- The DWBA 415 model is a double extension amplifier, valid for a two-cable system with two independent satellite TV circuits and a common one for terrestrial TV, in addition to the return path.
- The amplifier has been optimised by specific circuits which protect it against telecommunications services on adjacent frequency bands.
- Integrates a switch mode power supply to reduce the inside temperature and help extend the life of the equipment.



AMPLIFICATION

Supply voltage	230 Vac ± 15 %
Power consumption	15 VA
Operating temperature range	0 ÷ 50° C

MODEL	DA 353		DA 354		WBA 433			D WBA 415				
Reference	35920		35924		35930			35934				
Numbers of inputs	1		1		1			2				
Band coverage	MHz	5 ÷ 30**	47 ÷ 862	5 ÷ 30**	47 ÷ 862	5 ÷ 30**	47 ÷ 862	950 ÷ 2300	5 ÷ 30**	47 ÷ 862	950 ÷ 2300	
Max. output level *	dBµV	117	116	117	121(IM2=115 dBµV)	—	117	117	—	117	125	
Input / output impedance	Ω	75										
Return losses	dB	15	10	15	10	15	10	6	15	10	6	
Gain	dB	15	35	15	35	-2	35	34 - 41	-2	35	34 - 41	
Level adjustment	dB	20		20		—	20	20	—	20	20	
Equalisation	dB	—	20	—	20	—	0-20	—	—	0-18	—	
- Variable		—	—	—	—	—	—	7/14	—	—	7/14	
- Switchable		—	—	—	—	—	—	—	—	—	—	
Test output level	dB	1 IN - 1 OUT		1 IN - 1 OUT		1 IN - 1 OUT			2 OUT			
TEST output attenuation	dB	30										
Noise figure (typ.)	dB	9	6	9	6	—	6,5	8,5	—	6,5	8,5	
Input / output connectors		F (f)										
Protection rating		IP63										
Packing dimensions	mm	280 x 175 x 60										
Weight	Kg	3,1						3,2				

* 950 ÷ 2300 MHz: IM3 a -35 dB
 5 ÷ 862 MHz: IM3 a -60dB
 ** DA 353 A (Ref. 35922): 5 ÷ 66 return path
 ** DA 354 A (Ref. 35925): 5 ÷ 66 return path
 ** WBA 433 A (Ref. 35932): 5 ÷ 66 return path
 ** D WBA 415 A (Ref.35935): 5 ÷ 66 return path

SAB Series

Band amplification system with separate VHF and UHF signal processing, to reduce the IM2 products.

APPLICATION

Suitable as a distribution amplifier, or an extension amplifier for collectives.

SAB 401 is designed for working in high temperature environments.

SAB 301/SAB 301-A, broadband amplifiers which allow a complete processing of all TV channels, from 47 to 862 MHz. They can also be used as final amplifier in CATV network.

CHARACTERISTICS

- The circuit is housed in a single-part metal case which includes all the input-output connectors.
- It has shielding at the top and bottom, that assures a high level of mechanical rigidity and complete protection against electrical interference.
- SAB 301/SAB 301-A have return path, tilt regulation and test output.
- TEST output for signal monitoring



Supply voltage	230 Vac -10 % +15%
Current drawn	10 VA
Operating temperature range	0 ÷ 50° C

MODEL		SAB 401**	SAB 402	SAB 301	SAB 301-A
Reference		35415	35402	35301	35302
Number of inputs		1	1	1	1
Band coverage		BI, FM, BIII*, UHF	BI, FM, BIII*, UHF	47 ÷ 862 MHz	87,5 ÷ 862 MHz
Output level DIN 45004B (-60 dB)	dBµV	111	117	116	116
Gain	dB	40, 33, 40, 40	40, 33, 40, 40	28 ÷ 35	28 ÷ 35
Input / output impedance	Ω	75	75	75	75
Noise figure	dB	7, 7, 7, 6	7, 7, 7, 6	12...8	12...8
Regulation	dB	20	20	20	20
Tilt regulation	dB	—	—	0 ÷ 11	0 ÷ 11
Return path covered band	MHz	—	—	5 ÷ 30	5 ÷ 65
Return path insertion losses	dB	—	—	-3,5	-3,5
Packing dimensions	mm	250 x 125 x 62			
Weight	Kg	0,8			

* BIII : 132 - 300 MHz (S 05 - S 20)
 ** With + 24 V (20 mA) auxiliary output

**SAB 401 / SAB 402
 SAB 301/SAB 301-A**

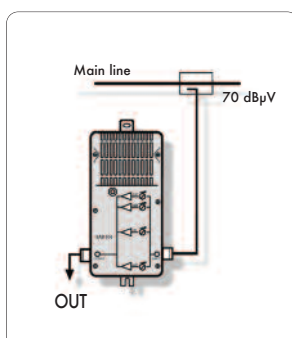

AMPLIFICATION

APPLICATION EXAMPLES

SABAL Series
WBA 433 Wide Band Amplifier

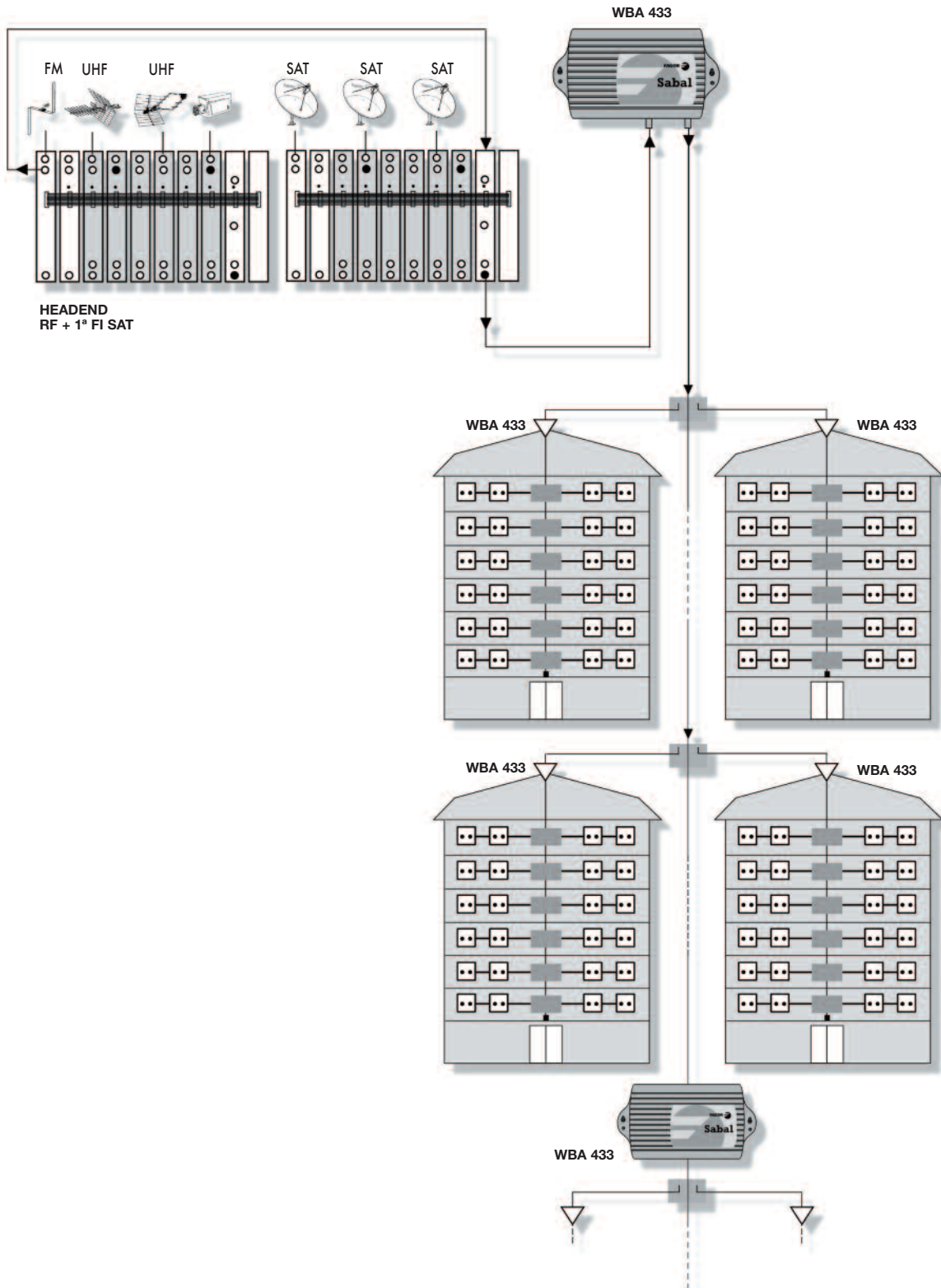

AMPLIFICATION

Tedi 3000 HD

CHARACTERISTICS

- DVB-T, MPEG-4, MPEG-2 standard compatible.
- USB 2.0 port.
- HDMI 1.3b output.
- "Time Shift" via USB 2.0. with recording option.
- Advanced reproduction functions: forward, rewind, previous/next, pause, go to, etc.
- Media player: plays photos, music, videos.. (MP3, JPEG, BMP and OGC files).
- Screen-format 16:9/4:3
- DVB EN300743 teletext and DVB ETS300472 teletext by VBI and OSD.
- Parental lock.
- Auto save function for last channel used.
- Software Upgrading via USB 2.0.
- Low consumption.
- Includes games: Tetris, Othello, Sudoku...

INCLUDES:

- Remote control
- Batteries: 2 x 1.5V AAA
- AC/DC adapter
- IR cable
- Installation manual



MODEL	Tedi 3000 HD
Reference	86524
Power supply voltage	AC 175 ~ 250V; 50/60Hz
Standby	0,5 W MAX.
Max. current at +5Vdc	50 mA
Input impedance	75 Ohm
RF input connector	IEC female, 9,5mm
Input frequency	177,5 ~ 227,5 MHz (BIII) 474 ~ 858 MHz (UHF)
ANT loop through	51 ~ 858 MHz
Input level range	64QAM:-78,5 ~ -8,75dBm /16QAM:-84 ~ -8,75dBm / QPSK:-90,3 ~ -8,75dBm
RF channel bandwidth	7 MHz, 8 MHz
HDMI output	19 PIN female; HDMI 1.3b
IR input	minijack 3,5mm
USB	USB 2.0
Constellation	QPSK, 16QAM, 64QAM
Video decode	MPEG2 ISO/IEC 13818-2 MP@ML, H.264 (MPEG4 part 10) 4.1/MPEG-2 MP@HL
Video resolution	480i,480p,576i,576p,720p,1080i,1080p
Audio decode	MPEG-1, MPEG-2 (Layer I/II), MP3, AC-3 (Dolby Digital),AAC-LC,WMA
Audio mode	Left/Right/Stereo/Mono
Operating temperature range	0-40° C
Packing dimensions	139 x 63 x 23
Weight	0,2 kg

Tedi 2000 HD

Reduced size high definition DTT receiver size suitable for those TVs that have HDTV compatible screens (Full HD, HD ready ...), but do not include MPEG 4 tuner.

APPLICATION

Reception of free digital terrestrial channels in HD.

CHARACTERISTICS

- Complies with DVB-T, MPEG-4, MPEG-2.
- USB port.
- HDMI (Auto, 576i, 576p, 720p, 1080i, 1080p and Highest).
- "Time Shift" Function.
- Timer function for program recording.
- Advanced features in playback: forward, rewind, up / down, pause, go to, etc).
- Media Player: playback of recordings, photos, music and movies (files . AVI, .MEPG, . JPEG, . GIF and BMP).
- Screen Format 16:9 / 4:3.
- Supports VBI Teletext, Teletext OSD and Subtitles Subtitles TXT standard.
- Parental lock and menu.
- Memorizes the last program.
- Software update via USB.
- Optical audio output
- Low consumption.



Tedi 2000 HD

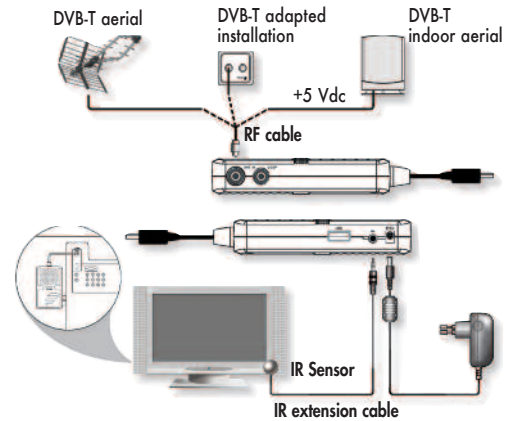

DTT RECEIVERS

MODEL	Tedi 2000 HD
Reference	86522
POWER SUPPLY	
Power supply voltage	AC 100~240V; 50/60Hz
Consumption	0,5 W MAX.
Max. Current +5Vdc	50 mA
HARDWARE	
Tuner	
Input impedance	75 Ohm
RF input connector	IEC female, 9,5 mm
Input frequency	174~230 MHz (BIII) 470~862 MHz (UHF)
Input frequency range	470 ~ 862 MHz
Input level	-10 dBm a -78 dBm
RF channel bandwidth	6 MHz, 7 MHz, 8 MHz
HDMI output	19 PIN female; HDMI 1.2
Connector	
Input IR	minijack 3,5mm
USB	USB 2.0
Constellation	QPSK, 16QAM, 64QAM
Transmission mode	2K, 8K FFT
FEC	1/2, 2/3, 3/4, 5/6, 7/8
Guard interval	1/4, 1/8, 1/16, 1/32
SYSTEM	
Video decoder	MPEG-4 AVC/H.264 MP@HP level 4.1 / MPEG-2 MP@ML
Video Resolution	1080i, 720p
Video Format	4:3, 16:9 / MPEG-1 layer I&II, MPEG-2 layer II, MPEG-2 AAC, MPEG-4 AAC
Audio decoder	LC 2ch/5.1 ch
Audio Mode	Left / Right / Stereo / Mono
FORMATS	
Compatible	.MP3, .MPEG, .MP4, .MKV, .AVI, .DIVX, .XVID, .JPG, .GIF, .BMP
REMOTE CONTROL	
Batteries	2 x 1,5V AAA
Working temperature	0-40° C
Packing dimensions	158 x158 x 58
Weight	0,3 kg

DES / DIS Series

Shielded tap-offs and splitters with saddle & clamp, suitable for digital signal distribution in community installations.

APPLICATION

Analogue and Digital Terrestrial TV Installations, both individual or community.

CHARACTERISTICS

- Maximum efficiency with minimum output level at headend.
- Same level between users in the same floor.
- Linear attenuation in the whole band.
- High signal levels can be used thanks to a special shielding design.
- Easy to set up.
- Valid for reduced space installations.
- Valid for DiseqC signals.



PI DES

REF.: 85013

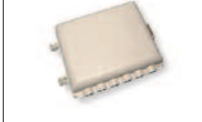

PI DES/DIS+S

REF.: 85016



MODEL		PI-DES	PI-DES/DIS +/s
Reference		85013	85016
Packing dimensions	mm	380 x 160 x 160	92 x 55 x 285
Weight	Kg	1,1	0,3

MODEL	SPLITTERS				TAP-OFFS								
	DIS 204 S	DIS 307 S	DIS 409+	DIS 513+	DES 211 S	DES 216 S	DES 220 S	DES 225 S	DES 411+	DES 416+	DES 420+	DES 425+	
Reference	85357	85358	85355	85356	85374	85375	85376	85377	85380	85381	85382	85383	
Nr of outputs	2	3	4	5 3/2	2				4				
Covered band	MHz				5 ÷ 2300								
IN-OUT	5 - 47 MHz	3,5	6,5	7,5	7,5 / 11	2,5	1,2	0,7	0,5	4	1,8	0,9	0,6
	47 - 550 MHz	3,5	6,5	7,5	7,5 / 11	2,2	1,1	0,8	0,5	3,5	1,8	0,9	0,6
	550 - 862 MHz	4	6,5	7,5	8 / 11,5	2,4	1,1	0,8	0,6	4	1,9	0,9	0,7
Insertion loss	950 - 1550 MHz	4,5	7,5	8,5	9 / 12,5	2,9	1,5	1	1	4,2	2,8	1,4	1,1
	1550 - 2150 MHz	5,5	8,5	9,5	10 / 13	3,2	1,5	1,2	1,4	4,4	3,2	1,9	1,6
	2150 - 2300 MHz	5,5	8,5	9,5	10,5 / 14	3,7	2	1,5	1,8	4,5	3,5	2	1,7
IN-TAP Tap loss	5 - 47 MHz					11	16	21	25	11	15,5	20	25
	47 - 550 MHz					11	16	21	25	11	16	20	25
	950 - 1550 MHz					11	16	21	25	11	16	20	25
	950 - 1550 MHz					11	16	21,5	25	12	16	20	25
	1550 - 2150 MHz					11,5	16,5	21,5	25	13	16	20	25,5
	2150 - 2300 MHz					11,5	16,5	21,5	25,5	13	16,5	20,5	25,5
Isolation OUT-TAP	47 - 950 MHz					23	24	25	25	23	25	25	25
	950 - 2150 MHz					20	21	25	25	23	25	25	25
OUT-OUT TAP-TAP isolation	47 - 862 MHz	24	24	24	24	21	22	22	25	21	21	22	21
	950 - 2150 MHz	22	22	22	22	21	22	22	25	21	21	22	23
IN Return loss	47 - 862 MHz	14	14	14	12	17	20	20	22	15	16	20	22
	950 - 2150 MHz	12	14	14	14	20	20	25	17	18	18	18	19
OUT Return loss	47 - 862 MHz	13	12	12	14	20	20	25	22	20	22	23	25
	950 - 2150 MHz	12	12	12	12	17	16	17	15	16	18	17	16
TAP Return loss	47 - 862 MHz					12	13	17	16	18	19	21	20
	950 - 2150 MHz					12	12	12	12	16	16	16	16
CD pass 24 Vcc, 0, 5A, 22 KHz	IN - OUT	NO	NO	NO	NO	YES							
	OUT - IN	YES	YES	YES	YES	YES							
CD pass 24 Vcc, 0, 5A, 22 KHz	IN - TAP					NO							
	TAP - IN					NO							
	TAP - TAP					NO							
						NO							
Packing dimensions (10 u.)	mm	118x108x61		185 x 90 x 50		118 x 108 x 61				185 x 90 x 50			
Weight (10 u.)	Kg	0,66		0,85		0,66				0,85			

CONNECTIONS



DISTRIBUTION

REP / DER Series

Tap-offs and splitters with "F" connector totally shielded.

APPLICATION

Analogue TV Installations, both individual or community.

CARACTERÍSTICAS

- • TAP- OFFS with 1, 2, 4, 6 and 8 outputs.
- Splitters with 2, 3, 4, 6 and 8 outputs.
- DC pass:
 - SPT: through outputs.
 - TAP: at the main input-output.
 - Allow cable passage at the back side.

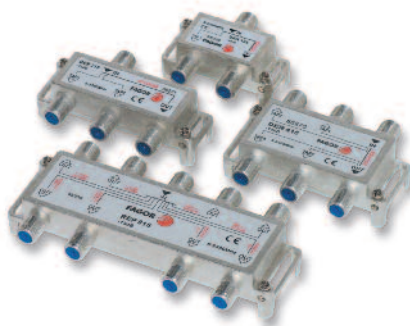

MODEL			SPLITTERS					TAP-OFFS							
			REP 204	REP 307	REP 409	REP 613	REP 815	DER 110	DER 115	DER 120	DER 125	DER 210	DER 215	DER 220	DER 225
Reference			85261	85262	85263	85264	85265	85266	85267	85268	85269	85270	85271	85272	85273
Nr. of outputs			2	3	4	6	8	1			2				
Covered band			MHz												
Tap Loss (± 0,5 dB)			5 - 2300 MHz												
Through loss			dB												
Directional isolation			dB												
Output isolation			dB												
Return losses			dB												
Min. screening factor			dB												
Packing dimensions (10 u.)			mm			mm							mm		
Weight (10 u.)			Kg			Kg							Kg		

MODEL			TAP-OFFS											
			DER 410	DER 415	DER 420	DER 425	DER 615	DER 620	DER 625	DER 815	DER 820	DER 825		
Reference			85274	85275	85276	85277	85278	85279	85280	85281	85282	85283		
Nr. of outputs			4				6			8				
Covered band			MHz											
Tap Loss (± 0,5 dB)			5 - 2300 MHz											
Through loss			dB											
Directional isolation			dB											
Output isolation			dB											
Return losses			dB											
Min. screening factor			dB											
Packing dimensions (10 u.)			mm				mm							
Weight (10 u.)			Kg				Kg							



DISTRIBUTION

DXR + Series

Shielded diplexer with saddle clamp connection.

APPLICATION

Suitable for digital or analogue TV installations.

- DXR 216 +: diplexer with 2 inputs / 1 output, suitable for splitting or combining RF/1st IF SAT.
- DXR 2D +: suitable for incorporating 1st IF SAT signals.

CARACTERÍSTICAS

- High shielding zamak chassis.
- Low loss and excellent frequency response.
- Easy to install in reduced areas.



DISTRIBUTION

MODEL	DXR 216+		DXR 2D+	
Reference	86244		86243	
DC pass 24 Vdc, 0.5A, 2 KHZ	SAT IN - OUT		—	
Covered bands	RF	SAT	RF	SAT
Frequency range MHz	15 ÷ 862	950 ÷ 2300	5 ÷ 862	950 ÷ 2300
Number of inputs	1	1	1	2 (SAT 1 and SAT 2)
Number of outputs	1		2 (SAT 1+ RF and SAT 2+ RF)	
Through loss dB	1,7	2	5	1(950-1200 MHz 2 dB)
Rejection, SAT input to RF dB	33		25	
Rejection, RF input to SAT dB	25		25	
Impedance Ω	75			
Return losses dB	10			
Packing dimensions (10 u.) mm	185 x 90 x 50			
Weight (10 u.) Kg	0,85			

CONNECTIONS



APPLICATION EXAMPLE DXR 2D +

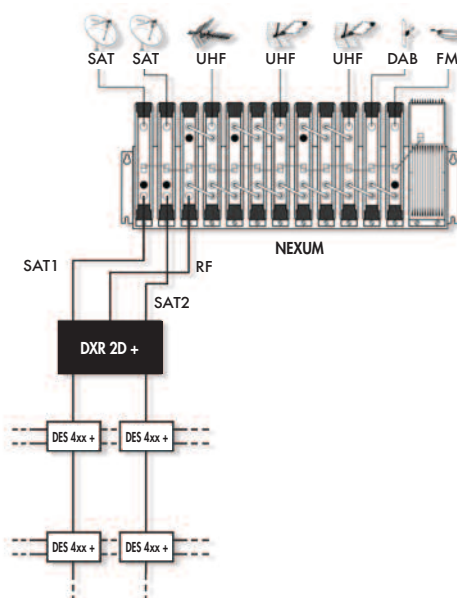

INTERNAL DIAGRAM DXR 2D +

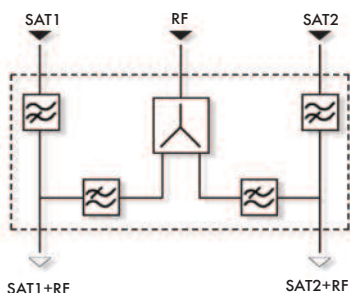

BIF Series

Outlet sockets with inductive devices for adequate filtering of the signals at the outputs, with minimum through losses.

APPLICATION

TV Installations, both individual or community to be used as end socket or for cascading.

CHARACTERISTICS

- The circuit has a metal (zamak) housing to achieve a high degree of shielding.
- It has a special shielding at the input and output connections, and it is designed for easy installation.
- The outlet's directivity guarantees enough isolation between floors.
- Compatible with most of the electrical devices available.

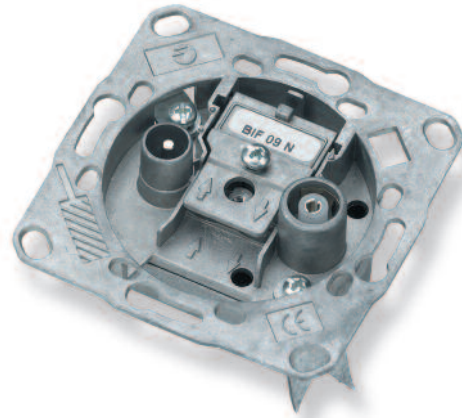

Frequency (MHz)	5	68	87,5	108	118	1000
TV	█					█
RADIO		█				

MODEL		BIF 01 S	BIF 01 N	BIF 05 N	BIF 09 N	BIF 14 N	BRF 00 N
Reference		85164	85159	85160	85161	85162	85163
Technology		Inductive					Resistive
Band coverage	MHz	5 ÷ 1000					
Through losses	Return path 5 - 68 MHz	Single*	End	2,5	1,5	1,2	2
	68 - 470 MHz			2,5	1	1,2	2
	470 - 1000 MHz			2,5	1	1,6	2
Derivation losses	Return path 5 - 68 MHz	0,5	2,5	7,5	11	13,5	1,5
	TV 118 - 470 MHz	0,5	3	7	11	15	1,5
	R 470 - 1000 MHz	0,5	3	7	11	15,2	1,5
	R 87,5 - 108 MHz	6	6	12,5	18	17	1,5
Directivity	TV - OUT	—	—	15			—
	R - OUT	—	—	30			—
Isolation	TV - R	30					—
Shielding factor	40 - 470 MHz	75					
	70 - 862 MHz	65					
Impedance	Ω	75					—
Return losses	dB	9,5					—
Output connectors (UNE 20-523-79)	R	IEC 9,5 (f)					
	TV	IEC 9,5 (m)					
Packing dimensions (20 u.)	mm	300 x 165 x 85					
Weight (20 u.)	Kg	1,5					

* BIF 01 S model must be connected directly to tap-off or splitter.

TV - FM COVER

MODEL	C BIF	C BIF B
Reference	85033	85034
Colour	beige	white
Packing dimensions (20 u.)	mm	190 x 90 x 85
Weight (20 u.)	Kg	0,5

SUPPLEMENT FOR SURFACE MOUNTING

MODEL	SS BT	SS BT B
Reference	85020	85031
Colour	beige	white
Packing dimensions (15 u.)	mm	260 x 135 x 90
Weight (15 u.)	Kg	0,5

OUTLET SOCKET FOR DATA

BID N Series



Frequency (MHz)	5	65	85	862
DATA	█		█	█
TV	█			

MODEL		BID 01 N	BID 10 N
Reference		85167	85168
Technology		Inductive	
Band coverage	MHz	5 ÷ 862	
Through losses	5 ÷ 862 MHz	End	4
	87,5 ÷ 90 MHz	6	9
Derivation losses	TV 90 ÷ 862 MHz	5	8
	DATA 5 ÷ 65 MHz	1	3,5
	DATA 87,5 ÷ 862 MHz	5	10
	TV - OUT	15	
Directivity	DATA - OUT	25	

BSD 200 Series

Outlet sockets with inductive devices for adequate filtering of the signals at the outputs, with minimum through losses.

APPLICATION

Suitable for Digital TV, up to 2300 MHz in individual and community installations.

CHARACTERISTICS

- The circuit has a metal (zamak) housing to achieve a high degree of shielding.
- It has a special shielding at the input and output connections, and it is designed for easy installation.
- The outlet's directivity guarantees enough isolation between floors.
- Compatible with most of the electrical devices available.



Frequency (MHz)	5	862	950	2300
TV	████████████████████			
SAT	████████████████████			

MODEL		BSD 201 F DC	BSD 201 S	BSD 201 SDC	BSD 203 N	BSD 203 DC	BSD 210 N	BSD 210 DC	BSD 215 N	BSD 220 N
Reference		86222	86218	86221	86205	86204	86219	86211	86215	86220
Number of outputs		2								
Band coverage	MHz	5 ÷ 2300								
DC pass	IN-OUT 300 mA max	—	—	—	—	—	—	yes	—	—
	SAT 300 mA max	yes	—	yes	—	yes	—	yes	—	—
Through losses	5 - 30 MHz	Single*			End		3,0	3,0	3,0	3,0
	47 - 862 MHz						2,5	2,0	1,8	
	950 - 2150 MHz						2,5	3,0	3,0	
	2150 - 2300 MHz						3,0	3,0	3,0	
Derivation losses	5 - 30 MHz	0,5			2,0		10	15,0	16,0	
	47 - 862 MHz	1			3,0		11,5	15,0	20,0	
	950 - 2150 MHz	1			3,0		12	16,0	20,0	
	2150 - 2300 MHz	1			3,0		12,5	16,0	22,0	
Directivity	5 - 30 MHz	—			—		15	23	25	
	47 - 862 MHz	—			—		22	23	25	
	950 - 2150 MHz	—			—		18	20	25	
	2150 - 2300 MHz	—			—		20	20	23	
Isolation TV-R	5 - 30 MHz	30			30		30	25	35	
	47 - 862 MHz	15			15		25	25	30	
	950 - 2150 MHz	15			15		15	15	25	
	2150 - 2300 MHz	18			18		25	20	30	
Return losses	5 - 862 MHz					10				
	950 - 2300 MHz					6				
Shielding factor	VHF					75				
	UHF					65				
	SAT					55				
Output connectors (UNE 20-523-79)	TV	IEC 9,5 (m)			IEC 9,5 (m)					
	SAT	F(f)			IEC 9,5 (f)					
Packing dimensions (20 u.)	mm	300 x 165 x 85								
Weight (20 u.)	Kg	2								

* BSD 201 S and BSD 201 SDC model must be connected directly to tap-offs or splitter.

TV - SAT COVER

MODEL	C BSD	C BSD B
Reference	86230	86231
Colour	beige	white
Packing dimensions 20 u.	mm 190 x 90 x 85	
Weight 20 u.	Kg 0,5	

SUPPLEMENT FOR SURFACE MOUNTING

MODEL	SS BT	SS BT B
Reference	85020	85031
Colour	beige	white
Packing dimensions 15 u.	mm 260 x 135 x 90	
Weight 15 u.	Kg 0,5	

BSD 400 Series

Outlet sockets for cascade mounting.

APPLICATION

Suitable for renovation of inhabited housing. Serial or cascade mounting. Select the model according to its derivation losses and the required level in the installation.

CHARACTERISTICS

- IN-OUT DC pass and at the SAT output (IEC female).
- 5÷2300 MHz output in male and female IEC connectors.
- Easy installation.
- High screening factor.
- Compatible with most of the electrical devices available.



Frequency (MHz)	5	862	950	2300
TV	████████████████████			
SAT	████████████████████			

MODEL		BSD 403 DC	BSD 411 DC	BSD 416 DC	BSD 420 DC	BSD 425 DC
Reference		86223	86224	86225	86226	86227
Number of outputs		2				
Band coverage	MHz	5 ÷ 2300				
DC pass	IN-OUT 300 mA max SAT 300 mA max	—	Yes			
Through losses	5 - 30 MHz	Final End	3,0	1,4	1,1	0,9
	47 - 862 MHz		2,5	1,2	1,0	0,9
	950 - 2150 MHz		3,0	2,2	2,1	2,0
	2150 - 2300 MHz		3,5	2,5	2,4	2,2
Derivation losses	5 - 30 MHz	4,5	11,0	16,5	21,5	25,0
	47 - 862 MHz	3,5	11,0	16,5	21,5	25,0
	950 - 2150 MHz	5,5	11,0	16,5	21,5	25,0
	2150 - 2300 MHz	6	11,0	16,5	21,5	25,0
Directivity	5 - 30 MHz	—	20	23	30	30
	47 - 862 MHz	—	23	23	30	30
	950 - 2150 MHz	—	18	20	20	20
	2150 - 2300 MHz	—	16	17	20	20
Isolation TV-R	5 - 30 MHz	5	17	17	17	20
	47 - 862 MHz	10	20	20	20	25
	950 - 2150 MHz	12	18	18	18	20
	2150 - 2300 MHz	12	18	18	18	20
Return losses	5 - 862 MHz	10		14		
	950 - 2300 MHz	10				
Shielding factor	VHF	75				
	UHF	65				
	SAT	55				
Output connectors (UNE 20-523-79)	TV SAT	IEC 9,5 (m) IEC 9,5 (f)				
Packing dimensions (20 u.)	mm	300 x 105 x 85				
Weight (20 u.)	Kg	2				

TV - SAT COVER

MODEL	C BSD	C BSD B
Reference	86230	86231
Color	beige	white
Packing dimensions 20 u.	mm 190 x 90 x 85	
Weight 20 u.	Kg 0,5	

SUPPLEMENT FOR SURFACE MOUNTING

MODEL	SS BT	SS BT B
Reference	85020	85031
Color	beige	white
Packing dimensions 15 u.	mm 260 x 135 x 90	
Weight 15 u.	Kg 0,5	



BSD 300 Series

Outlet sockets with 3 outputs TV, Radio and SAT.

APPLICATION

Suitable for Digital TV, up to 2300 MHz in individual and community installations.

CHARACTERISTICS

- The circuit has a metal (zamak) housing to achieve a high degree of shielding.
- It has a special shielding at the input and output connections, and it is designed for easy installation.
- The outlet's directivity guarantees enough isolation between floors.
- Compatible with most of the electrical devices available.

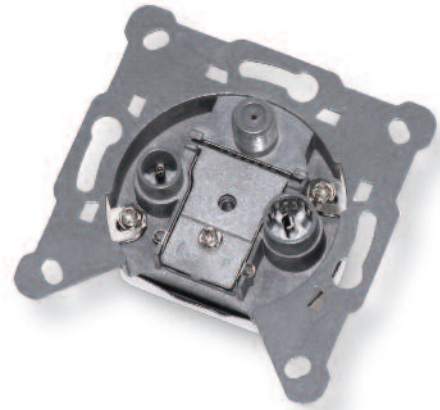

Frequency (MHz)	5	68	88	108	125	862	950	2300
TV	■				■			
RADIO			■					
SAT							■	

MODEL			BSD 301 (Final)	BSD 310 (Cascade)
Reference			86233	86234
Outputs			3 (TV / FM / SAT)	
Band coverage		MHz	5 ÷ 2300	
DC pass			SAT-IN	SAT-IN / OUT-IN
Through losses		5 - 2300 MHz	dB	5
Derivation losses	TV	5 - 68 MHz	dB	10
	FM	125 - 862 MHz	dB	10
	SAT	88 - 108 MHz	dB	10
Isolation		950 - 2300 MHz	dB	10
	FM-TV	5 - 68 MHz	dB	20
		88 - 108 MHz	dB	20
		125 - 862 MHz	dB	20
	FM-SAT	88 - 108 MHz	dB	20
Output connectors	TV	5 - 860 MHz		20
	FM	950 - 2300 MHz		20
	SAT			
Packing dimensions (20 u.)		mm	300 x 165 x 85	
Weight (20 u.)		Kg	2	

CCF Series

Low loss cables for use in CATV signal distribution in community and individual MATV-SMATV installations.

APPLICATION

- CCF SAT is valid for 1st IF SAT installations.
- CCF 017 & CCF 020 is used in general distribution.
- CCF SAT H is a low smoke halogen free cable (LSHF).
- CCF TRA & CCF TRN:are valid for trunk installations.

CHARACTERISTICS

- Black cables should be used for distribution where PE cables are to be exposed to sunlight.

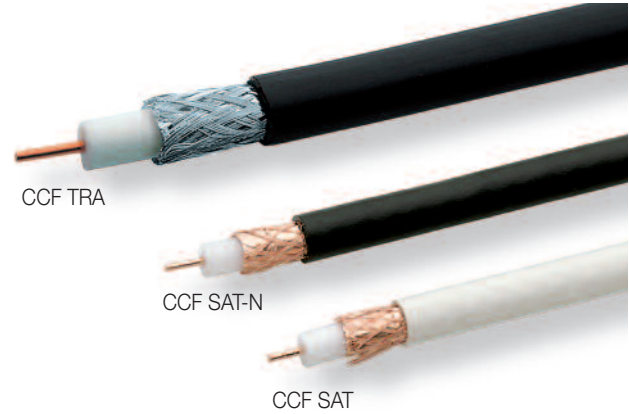

DISTRIBUTION

MODEL	CCF TRA	CCF SAT CCF SAT N	CCF SAT H	CCF 019 CCF 019 N	CCF 017	CCF 020	CCF 017 A	
Internal conductor	Cu							Cu steel
Material	Cu							Cu steel
Diameter mm	1,63	1,1	1,1	1	1,15	1	1,2	
Resistance Ω/Km	9	20	19	23	20	22	80	
Dielectric	PE							
Material	PE							
Diameter mm	7,2	4,8	4,8	4,8	4,9	4,6	4,8	
External conductor	Al / Pet / Al							
Material sheet	Al / Pet / Al	Cu / Pet			Al / Pet / Al			
Material net	CuSn	Cu			Al			
Resistance Ω/Km	8	22	21	30	33	46	35	
External conductor								
Diameter mm	10,1	6,7	6,8	6,8	6,9	6,6	6,7	
Min. curvature radius mm	80	40						
Attenuation / 100 m:								
50 MHz	3,1	4,8	4,4	4,7	4,8	4,5	4,2	
100 MHz	4,4	6,5	6,2	6,5	6,4	6,6	6,2	
200 MHz	6,3	8,6	8,7	8,8	8,5	8,6	8,7	
300 MHz	7,7	10	10,7	10,3	9,8	10,2	9,9	
470 MHz	9,6	12,5	13,4	12,8	12,3	12,7	12,4	
600 MHz	10,8	14,9	15,1	14,9	14,5	15,1	14,5	
860 MHz	13	17,9	18,1	17,8	17,4	18,1	17,2	
1000 MHz	14	22,2	19,5	20	22,3	19,4	22	
1350 MHz	16,2	22,4	22,7	21,6	22,2	21	23,1	
1500 MHz	17,1	23,5	23,9	22,6	23,3	24,4	24,1	
1750 MHz	18,5	25,7	25,8	26,4	25,8	26,4	25,3	
2050 MHz	20	27,6	27,9	29,5	28,2	29,3	27,5	
2150 MHz	20,5	28,9	28,6	30,9	29,6	30,7	28,2	
Shielding attenuation								
30-1000 MHz	95	85			75		85	
1001-2000 MHz	85	75			65		75	
2001-3000 MHz	75	65			55		65	
Capacity pF/m	54			55				
Impedance Ω	75							
Reflection point dB	< -20							

MODEL	CCF TRA	CCF SAT		CCF SAT N		CCF SAT H		CCF 019		CCF 017	CCF 020	CCF 017 A	
Reference	84111	84102	84123	84104	84105	84112	84133	84019	84119	84020	84127	84129	84113
Coil length	250	250	100/500	250	100	250	100/500	250	100/500	250	100/500	100/500	100/500
Coil support	wood	cardboard	cardboard	cardboard	cardboard	plastic	cardboard	cardboard	cardboard	cardboard	cardboard	cardboard	cardboard
External conductor	PE black	PVC white	PVC white	PE black	PE black	LSFH white	LSFH white	PVC white	PVC white	PE black	PVC white	PVC white	PVC white
Packing dimensions	360 x 360 x 350	360 x 360 x 180	270 x 270 x 660	360 x 360 x 180	270 x 270 x 660	265 x 265 x 300	270 x 270 x 660	360 x 360 x 180	270 x 270 x 660	360 x 360 x 180	270 x 270 x 660	270 x 270 x 660	270 x 270 x 660
Weight	25,5	12	5/25	10	5/25	10,5	5,5/28	12	5/25	10	4,5/23	4,5/23	4/20

ACCESSORIES

DISTRIBUTION

F (m) CONNECTOR



TYPE OF CABLE	MODEL	REF.
CCF 017/019/020/SAT or similar	CNR MF	84012

HIGH SHIELDING CONNECTORS

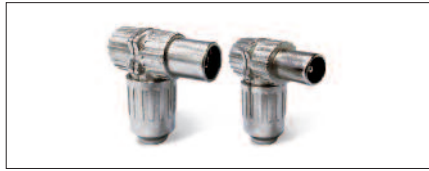

TYPE OF CONNECTOR	MODEL	REF.
IEC 9,5 (m)	CNR MI S	84038
IEC 9,5 (f)	CNR HI S	84039

SHIELDED CONNECTOR



TYPE OF CONNECTOR	MODEL	REF.
IEC 9,5 (m)	CNR MI	84028
IEC 9,5 (f)	CNR HI	84029

CONNECTOR

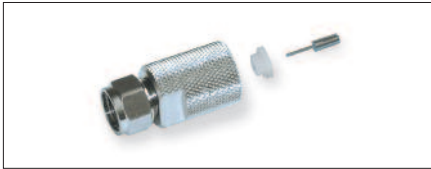

TYPE OF CABLE	MODEL	REF.
CCF TRN / CCF TRA	CNR F TRN	84014

BROAD BAND AMPLIFIER (UHF)

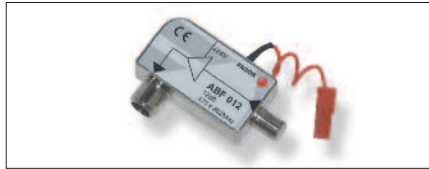

TYPE OF CONNECTOR	MODEL	REF.
F(f)-F(m)	ABF 012	85053

1st IF SAT LINE AMPLIFIER



TYPE OF CONNECTOR	MODEL	REF.
F (f)-F (m)	AL 46	86246

ADJUSTABLE ATTENUATOR



TYPE OF CONNECTOR	MODEL	REF.
IEC (f)-IEC (m)	AT 323	85005
IEC (f)-IEC (m)	AT 020	85007

ADJUSTABLE ATTENUATOR



TYPE OF CONNECTOR	MODEL	REF.
F(f)-F(m)	ATF 020	85050

FIX ATTENUATOR



TYPE OF CONNECTOR	MODEL	REF.
F (m)-F (f)	FAT 010	85041

75 Ω F LOAD



TYPE OF CONNECTOR	MODEL	REF.
F (m)	CX 75 F	84011

TWO WAY SPLITTER COMBINER

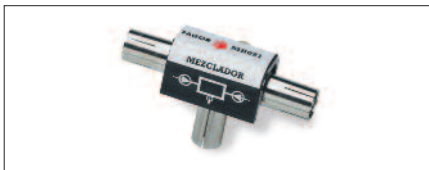

TYPE OF CONNECTOR	MODEL	REF.
2 x IEC(f) - 1 x IEC (m)	MB 021	85001

TWO WAY SPLITTER COMBINER



TYPE OF CONNECTOR	MODEL	REF.
2 x IEC(m) - 1 x IEC (f)	DB 012	85002

ACCESSORIES

TWO WAY SPLITTER COMBINER

Band coverage: 5 ÷ 862 MHz
 Impedance: 75 Ω
 Combining losses: 4 dB
 Output isolation: 22 dB

TYPE OF CONNECTOR	MODEL	REF.
F (f)	MD 012F	85028



75 Ω F-F COAXIAL BRIDGE

Rigid 75 Ω coaxial bridge for splitting or combining RF signals.
 Raster: 47,7 mm. (Ref. 8314) Serie 8000
 Raster: 48 mm. (Ref. 84031 y 84003)
 Multi-processing system
 Raster: 40 mm. (Ref. 84034)
 Nexum system

TYPE OF CONNECTOR	MODEL	REF.
F (m) - F (m)	PMD 8000	83814
F (m) - F (m)	PMD FF	84031
F (m) - F (m)	PMD FFN	84034

PMD FF



PMD FF N



“F” ADAPTOR

Female-female F adapter (5 ÷ 2300 MHz).

TYPE OF CONNECTOR	MODEL	REF.
F(f)-F(f)	ADF HHS	84016



SUPPLY INJECTOR

Frequency band: 5 to 2150 MHz
 Return losses: -10 dB
 Through losses: 0,5 dB
 DC pass: 1A

TYPE OF CONNECTOR	MODEL	REF.
F(f)-F(m)	ICF 001	85051

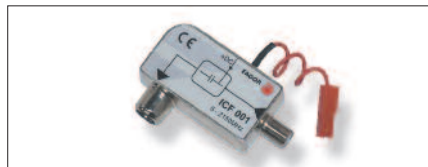

LOADING RESISTOR

75 Ω resistor suitable for loading unused inputs/outputs.

TYPE OF CONNECTOR	MODEL	REF.
—	RC 075	85010

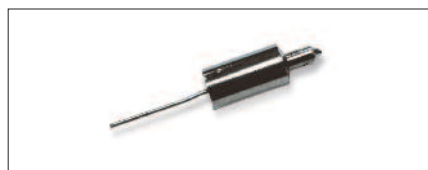

DOUBLE TRAP FILTER

Frequency band: 470 to 862 MHz
 In band return losses (out of notch filter): >10 dB
 Rejection at central frequency (Fc): 18 dB at 470 MHz / 10 dB at 862 MHz
 Rejection at Fc ± 12 MHz: 2 dB
 In band through losses: <1 dB
 DC pass: 1 A

TYPE OF CONNECTOR	MODEL	REF.
F(f)-F(m)	FTF 245	85052



HIGH PASS FILTER

Passage band: 470 to 1000 MHz
 Insertion losses: 1,5 dB
 Return losses: 10 dB
 Impedance: 75 Ohm.

TYPE OF CONNECTOR	MODEL	REF.
F (m)-F (f)	FPA 470	85042



ACCESSORIES

SAFE 100 Series

SURGE ARRESTER 90 V

Surge arrester to protect the installation against atmospheric discharges.

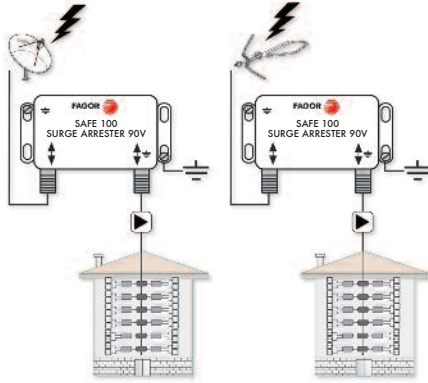

MODEL		SAF E 100
Reference		85040
Frequency band	MHz	0-2150
Insertion Losses	dB	0,5
Return Losses	dB	12
Impedance	Ω	75
Connectors		F (f)
DC spark over voltage @ 100V/s	V	90
Impulse spare-over voltage @1 KV/ μ s		600
Impulse discharge current 10 times	KA	5
Insulation Resistance at 100 Vdc	GOhm	10
DC pass	mA	500

LTE PROTECTION FILTERS

LBF Series

Low pass filters for protection againsts interfering LTE signals.

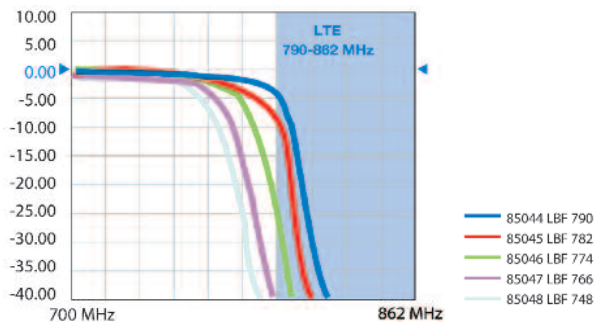

MODEL	LBF 790	LBF 782	LBF 774	LBF 766	LBF 758
Reference	85044	85045	85046	85047	85048
Pass Band	MHz 5÷790	MHz 5÷782	MHz 5÷774	MHz 5÷766	MHz 5÷758
Rejected Band	MHz 822÷2200	MHz 814÷2200	MHz 806÷2200	MHz 798÷2200	MHz 790÷2200
Rejection	dB ≥ 45				
Through loss	dB $\leq 1,5$				
Return loss	dB ≥ 12				
Type of connector	F(m)-F(f)				

CHANNEL DEFINITION

TV BAND	CHANNEL	CHANNEL LIMITS	PICTURE CARRIER	AUDIO CARRIER	
		MHz	MHz	MHz	
Standard B	Italy				
BI	A	52,5 - 59,5	53,75	59,25	
	B	61 - 68	62,25	67,75	
B (II)	C	81 - 88	82,25	87,75	
B (III)	D	174 - 181	175,25	180,75	
	E	182,5 - 189,5	183,75	189,25	
	F	191 - 198	192,25	197,75	
	G	200 - 207	201,25	206,75	
	H	209 - 216	210,25	215,75	
	H1	216 - 223	217,25	222,75	
	H2	223 - 230	224,25	229,75	
Standard D	OIRT				
BI	I	48,5 - 56,5	49,75	56,25	
	II	58 - 66	59,25	65,75	
	III	76 - 84	77,25	83,75	
B (II)	IV	84 - 92	85,25	91,75	
	V	92 - 100	93,25	99,75	
BIII	VI	174 - 182	175,25	181,75	
	VI	182 - 190	183,25	189,75	
	VIII	190 - 198	191,25	197,75	
	IX	198 - 206	199,25	205,75	
	X	206 - 214	207,25	213,75	
	XI	214 - 222	215,25	221,75	
	XII	222 - 230	223,25	229,75	
	Standard I	Ireland			
	BI	A	44,5 - 52,5	45,75	51,75
		B	52,5 - 60,5	53,75	59,75
		C	60,5 - 68,5	61,75	67,75
	BIII	D	174 - 182	175,25	181,25
E		182 - 190	183,25	189,25	
F		190 - 198	191,25	197,25	
G		198 - 206	199,25	205,25	
H		206 - 214	207,25	213,25	
I		214 - 222	215,25	221,25	
J		222 - 230	223,25	229,2	
Standard L		France			
BI		2	49,00 - 57,00	49,25	55,75
		3	53,75 - 61,75	54,00	60,50
	4	57,00 - 65,00	57,25	63,75	
BIII	5	174,75 - 182,75	176,00	182,50	
	6	182,75 - 190,75	184,00	190,50	
	7	190,75 - 198,75	192,00	198,50	
	8	198,75 - 206,75	200,00	206,50	
	9	206,75 - 214,75	208,00	214,50	
	10	214,75 - 222,75	216,00	222,50	

STANDARD B

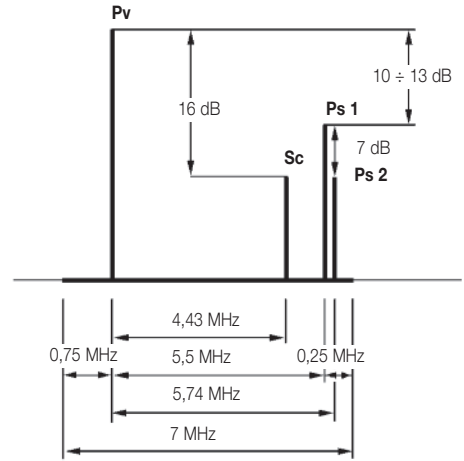

STANDARD G

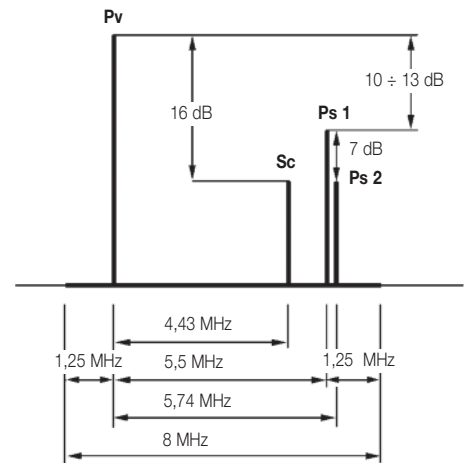

STANDARD L

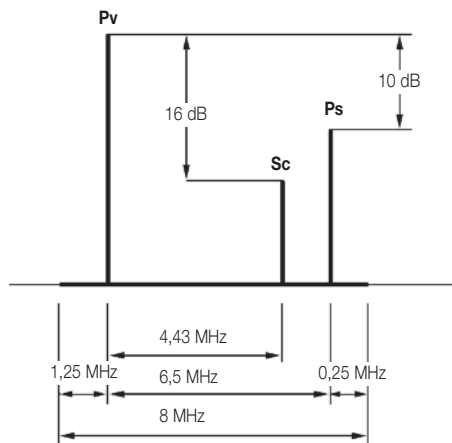

STANDARD I

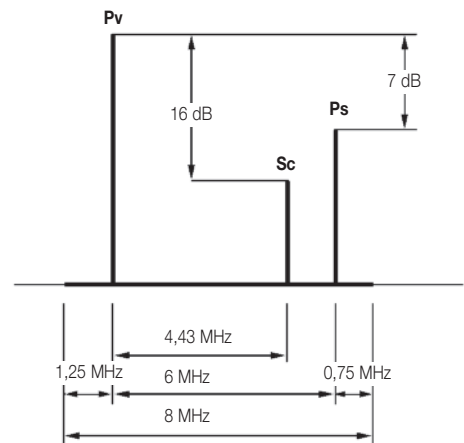

TECHNICAL NOTES

CCIR STANDARDS

CCIR-Standard	B	D	G	H	I	K	L	M	N
Number of lines	625	625	625	625	625	625	625	525	625
Channel Bandwidth	7	8	8	8	8	8	8	6	6
Video Bandwidth (MHz)	5	6	5	5	5,5	6	6	4,2	4,2
Video sound spacing	+5,5	+6,5	+5,5	+5,5	+6	+6,5	+6,5	+4,5	+4,5
Vestigial side band (MHz)	0,75	0,75	1,25	1,25	1,25	0,75	1,25	0,75	0,75
Picture modulation	Neg.	Neg.	Neg.	Neg.	Neg.	Neg.	Pos.	Neg.	Neg.
Sound modulation	FM	FM	FM	FM	FM	FM	AM	FM	FM

COUNTRY	VHF	UHF	TV STANDARD
Algeria	B	H	PAL
Argentina	N	N	PAL-N
Australia	B	H	PAL
Austria	B	G	PAL
Bahrein	B	G	PAL
Belgium	B	H	PAL
Bulgary	D	K	SECAM
China	D	K	PAL
Cyprus	B	G	PAL/SECAM
Czech Rep.	D	K	SECAM
Denmark	B	G	PAL
Egypt	B	G; H	SECAM
Finland	B	G	PAL
France	L	L	SECAM
Germany	B	G	PAL
Gibraltar	B	G	PAL
Great Britain	I	I	PAL
Greece	B	G	SECAM
Holland	B	G	PAL
Hong Kong	I	I	PAL
Hungary	D	K	SECAM
Iceland	B	G	PAL
India	B	—	PAL
Indonesia	B	—	PAL
Irak	B	—	SECAM
Iran	B	G	SECAM
Ireland	I	I	PAL
Israel	B	G	PAL
Italy	B	G	PAL
Japan	M	M	NTSC
Jordan	B	G	PAL
Korea	M	—	NTSC
Kuwait	B	G	PAL
Lebanon	B	—	SECAM
Libya	B	H	SECAM
Luxembourg	B/L	G/L	SECAM/PAL
Malaysia	B	G	PAL

COUNTRY	VHF	UHF	TV STANDARD
Malta	B	H	PAL
Mexico	M	M	NTSC
Monaco	E	L/G	SECAM/PAL
Morocco	B	H	SECAM
Nigeria	B	G	PAL
Norway	B	G	PAL
Oman	B	G	PAL
Pakistan	B	G	PAL
Philippines	M	M	NTSC
Poland	D	K	SECAM
Portugal	B	G	PAL
Quatar	B	G	PAL
Romania	D	K	PAL
Saudi Arabia	B	G	PAL/SECAM
Singapore	B	G	PAL
Southafrica	I	I	PAL
Spain	B	G	PAL
Sri Lanka	B	—	PAL
Sweden	B	G	PAL
Switzerland	B	G	PAL
Syria	B	—	SECAM
Thailand	B/M	—	PAL
Tunisia	B	G	SECAM
Turkey	B	G	PAL
U.A.E.	B	G	PAL
U.S.A.	M	M	NTSC
Yemen	B	—	PAL
Yugoslavia	B	G	PAL

CCIR = Comité Consultatif International des Radiocommunications
 PAL = Phase Alternation Line
 SECAM = Séquentielle à mémoire
 NTSC = National Television System Committee

FREQUENCY ALLOCATIONS

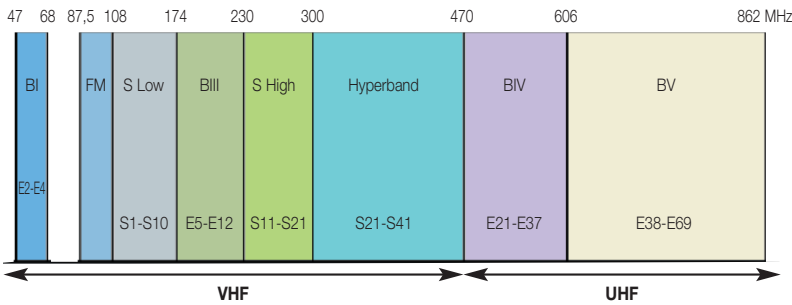

CHANNELS ACCORDING TO CCIR, B, G, I (EUROPE) STANDARDS

CHANNEL	CHANNEL BANDWIDTH	VIDEO (B)	AUDIO (B)	CENTRAL FREQ.	
		MHz	MHz	MHz	
VHF BI	2	47...54	48,25	50,5	
	3	54...61	55,25	57,5	
	4	61...68	62,25	64,5	
VHF Bs (low)	S1	104...111	105,25	110,75	
	S2	111...118	112,25	114,5	
	S3	118...125	119,25	124,75	
	S4	125...132	126,25	131,75	
	S5	132...139	133,25	138,75	
	S6	139...146	140,25	145,75	
	S7	146...153	147,25	152,75	
	S8	153...160	154,25	159,75	
	S9	160...167	161,25	166,75	
	S10	167...174	168,25	173,75	
VHF BIII	5	174...181	175,25	180,75	
	6	181...188	182,25	187,75	
	7	188...195	189,25	194,75	
	8	195...202	196,25	201,75	
	9	202...209	203,25	208,75	
	10	209...216	210,25	215,75	
	11	216...223	217,25	222,75	
	12	223...230	224,25	229,75	
	VHF Bs (high)	S11	230...237	231,25	236,75
		S12	237...244	238,25	243,75
		S13	244...251	245,25	250,75
		S14	251...258	252,25	257,75
S15		258...265	259,25	264,75	
S16		265...272	266,25	271,75	
S17		272...279	273,25	278,75	
S18		279...286	280,25	285,75	
S19		286...293	287,25	292,75	
S20		293...300	294,25	299,75	
VHF Hyperband		S21	302...310	303,25	308,75
		S22	310...318	311,25	316,75
	S23	318...326	319,25	324,75	
	S24	326...334	327,25	332,75	
	S25	334...342	335,25	340,75	
	S26	342...350	343,25	348,75	
	S27	350...358	351,25	356,75	
	S28	358...366	359,25	364,75	
	S29	366...374	367,25	372,75	
	S30	374...382	375,25	380,75	
	S31	382...390	383,25	388,75	
	S32	390...398	391,25	396,75	
	S33	398...406	399,25	404,75	
	S34	406...414	407,25	412,75	
	S35	414...422	415,25	420,75	
	S36	422...430	423,25	428,75	
	S37	430...438	431,25	436,75	
	S38	438...446	439,25	444,75	
	S39	446...454	447,25	452,75	
	S40	454...462	455,25	460,75	
	S41	462...470	463,25	468,75	

CHANNEL	CHANNEL BANDWIDTH	VIDEO G, I	AUDIO G I	CENTRAL FREQ.		
		MHz	MHz	MHz		
UHF	21	470...478	471,25	476,75	477,25	474
	22	478...486	479,25	484,75	485,25	482
	23	486...494	487,25	492,75	493,25	490
	24	494...502	495,25	500,75	501,25	498
	25	502...510	503,25	508,75	509,25	506
	26	510...518	511,25	516,75	517,25	514
	27	518...526	519,25	524,75	525,25	522
	28	526...534	527,25	532,75	533,25	530
	29	534...542	535,25	540,75	541,25	538
	30	542...550	543,25	548,75	549,25	546
	31	550...558	551,25	556,75	557,25	554
	32	558...566	559,25	564,75	565,25	562
	33	566...574	567,25	572,75	573,25	570
	34	574...582	575,25	580,75	581,25	578
	35	582...590	583,25	588,75	589,25	586
	36	590...598	591,25	596,75	597,25	594
	37	598...606	599,25	604,75	605,25	602
	38	606...614	607,25	612,75	613,25	610
	39	614...622	615,25	620,75	621,25	618
	40	622...630	623,25	628,75	629,25	626
	41	630...638	631,25	636,75	637,25	634
	42	638...646	639,25	644,75	645,25	642
	43	646...654	647,25	652,75	653,25	650
	44	654...662	655,25	660,75	661,25	658
	45	662...670	663,25	668,75	669,25	666
	46	670...678	671,25	676,75	677,25	674
	47	678...686	679,25	684,75	685,25	682
	48	686...694	687,25	692,75	693,25	690
	49	694...702	695,25	700,75	701,25	698
	50	702...710	703,25	708,75	709,25	706
	51	710...718	711,25	716,75	717,25	714
	52	718...726	719,25	724,75	725,25	722
	53	726...734	727,25	732,75	733,25	730
	54	734...742	735,25	740,75	741,25	738
	55	742...750	743,25	748,75	749,25	746
	56	750...758	751,25	756,75	757,25	754
	57	758...766	759,25	764,75	765,25	762
	58	766...774	767,25	772,75	773,25	770
	59	774...782	775,25	780,75	781,25	778
	60	782...790	783,25	788,75	789,25	786
	61	790...798	791,25	796,75	797,25	794
	62	798...806	799,25	804,75	805,25	802
	63	806...814	807,25	812,75	813,25	810
	64	814...822	815,25	820,75	821,25	818
	65	822...830	823,25	828,75	829,25	826
	66	830...838	831,25	836,75	837,25	834
	67	838...846	839,25	844,75	845,25	842
	68	846...854	847,25	852,75	853,25	850
	69	854...862	855,25	860,75	861,25	858



CONVERSION TABLE

$\mu\text{V } 75 \Omega$	$\text{dB}\mu\text{V}$	dBm
1	0	-109
1,5	3,5	-105,5
2	6	-103
2,5	8,0	-101
3	9,5	-99,5
3,5	11	-98
4	12	-97
4,5	13	-96
5	14	-95
6	15,5	-93,5
7	17	-92
8	18	-91
9	19	-90
10	20	-89
15	23,5	-85,5
20	26	-83
25	28	-81
30	29,5	-79,5
35	31	-78
40	32	-77
45	33	-76
50	34	-75
60	35,5	-73,5
70	37	-72
80	38	-71
90	39	-70
100	40	-69
150	43,5	-66,5
200	46	-63
250	48	-61
300	49,5	-59,5
350	51	-58
400	52	-57
450	53	-56
500	54	-55
600	55,5	-53,5
700	57	-52
800	58	-51
900	59	-50

$\text{mV } 75 \Omega$	$\text{dB}\mu\text{V}$	dBm
1	60	-49
1,5	63,5	-45,5
2	66	-43
2,5	68	-41
3	69,5	-39,5
3,5	71	-38
4	72	-37
4,5	73	-36
5	74	-35
6	75,5	-33,5
7	77	-32
8	78	-31
9	79	-30
10	80	-29
15	83,5	-25,5
20	86	-23
25	88	-21
30	89,5	-19,5
35	91	-18
40	92	-17
45	93	-16
50	94	-15
60	95,5	-13,5
70	97	-12
80	98	-11
90	99	-10
100	100	-9
150	103,5	-5,5
200	106	-3
250	108	-1
300	109,5	+0,5
350	111	+2
400	112	+3
450	113	+4
500	114	+5
600	115,5	+6,5
700	117	+8
800	118	+9
900	119	+10
1.000	120	+11

$\text{V } 75 \Omega$	$\text{dB}\mu\text{V}$	dBm
1	120	+11
1,5	123,5	+14,5
2	126	+17
2,5	128	+19
3	129,5	+20,5
3,5	131	+22
4	132	+23
4,5	133	+24
5	134	+25
6	135,5	+26,5
7	137	+28
8	138	+29
9	139	+30
10	140	+31

dB ratio /factor		
x(-)	dB	(+) x
1,0	0,0	1,0
0,94	0,5	1,06
0,89	1	1,12
0,84	1,5	1,19
0,8	2	1,25
0,75	2,5	1,33
0,71	3	1,41
0,67	3,5	1,5
0,63	4	1,6
0,6	4,5	1,67
0,56	5	1,78
0,53	5,5	1,88
0,5	6	2,0
0,47	6,5	2,12
0,45	7	2,24
0,42	7,5	2,37
0,4	8	2,5
0,38	8,5	2,66
0,35	9	2,82
0,33	9,5	3,0
0,32	10	3,16
0,28	11	3,55
0,25	12	4,0
0,22	13	4,5
0,2	14	5,0
0,18	15	5,62
0,16	16	6,3
0,14	17	7,1
0,125	18	8,0
0,11	19	8,9
0,10	20	10,0
0,089	21	11,2
0,08	22	12,5
0,071	23	14,1
0,063	24	16,0
0,056	25	17,8
0,05	26	20,0
0,045	27	22,4
0,04	28	25,0
0,035	29	28,2
0,032	30	31,6
0,028	31	35,5
0,025	32	40
0,022	33	45
0,02	34	50
0,018	35	56
0,016	36	63
0,014	37	71
0,0125	38	80
0,011	39	89
0,010	40	100
0,0056	45	178
0,0032	50	316
0,0018	55	562
0,001	60	1.000

BROAD BAND AMPLIFIERS

Reduction of the output level for broadband amplifiers according to the number of channels.

Nr. of digital channels	2	4	5	6	8	16	24	32	64
Reduction of the output level (Rc) dB	-3	-6	-7	-8	-9	-12	-14	-15	-18

Nr. of analogue channels	2	4	5	6	8	16	24	32	64
Reduction of the output level (Rc) dB	0	-3	-4	-5	-6	-9	-11	-12	-15

CASCADE AMPLIFICATION

Reduction of output level for broadband amplifiers according to the number of cascade amplifiers in the system.

Nr. of amplifiers	—	2	3	4	5	6	7
Reduction of output level (RA) dB	0	3	4,8	6	7	7,8	8,5

The output level of the amplifiers must be reduced according to the table above to keep the intermodulation products at the same level.

- $N_s = N_s - R_c - R_A$
- $N_s = \text{Max. operating level.}$
- $N_s = \text{Output level (DIN 45004 B, IM3 -60 dB).}$
- $R_c = \text{Reduction by nr. of channels.}$
- $R_A = \text{Reduction by nr. of amplifiers}$



Fagor Electrónica, S.Coop.

San Andrés, s/n.
E-20500 Mondragón (Spain)
Tel.: 943 712526
Fax: 943 712893
E-mail: rf.sales@fagorelectronica.es

www.fagorelectronica.com